

T1
+
TORNILLO

T2
+
TORNILLO

T3
+
TORNILLO

T4
+
TORNILLO

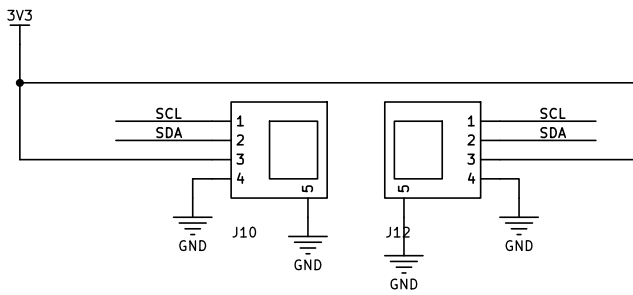
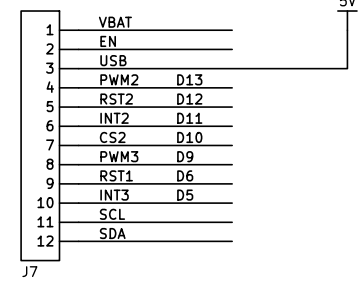
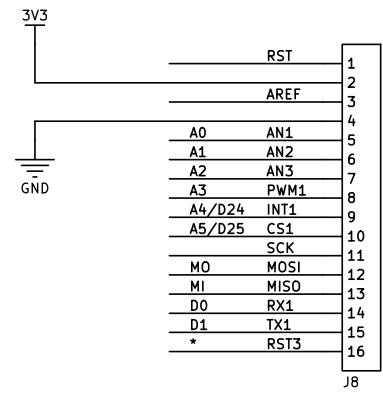
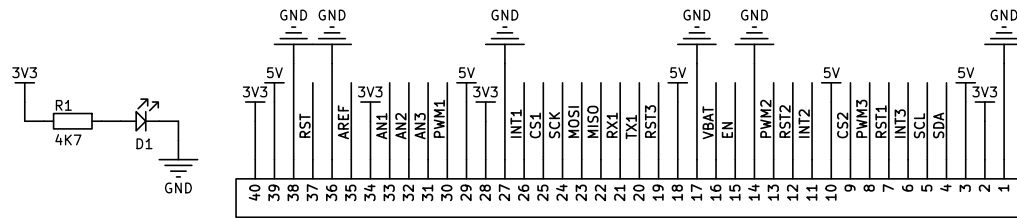
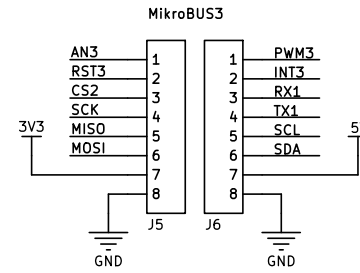
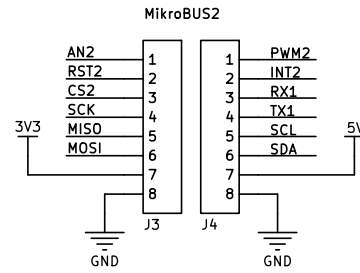
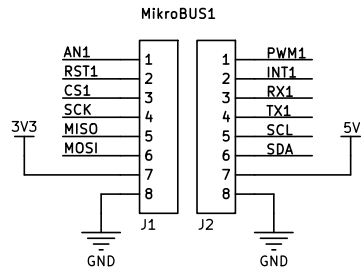

www.microside.com/xide

Title: X-BOARD Feather		
XB10 MICROSIDE TECHNOLOGY		
Rev: R1		
Date: 2023-05-31		

Microside Technology no asume responsabilidad alguna por errores o inexactitudes que puedan aparecer en el presente documento. Las especificaciones y la información contenidas en el presente esquemático están sujetas a cambios en cualquier momento sin previo aviso.