

T1
TORNILLO

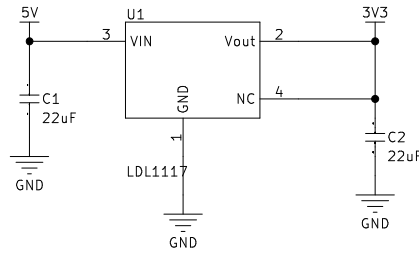

T2
TORNILLO

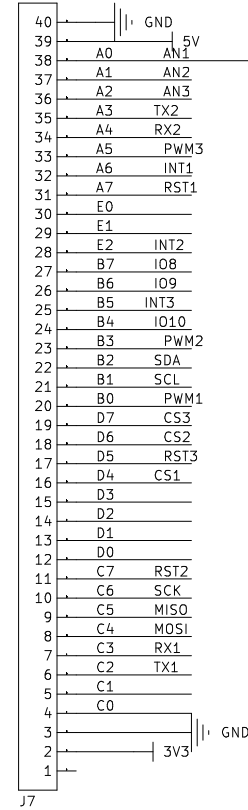

MikroBUS1

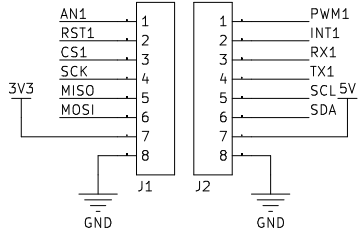

MikroBUS2

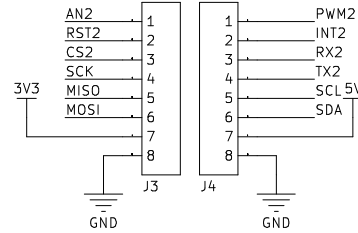

MikroBUS3

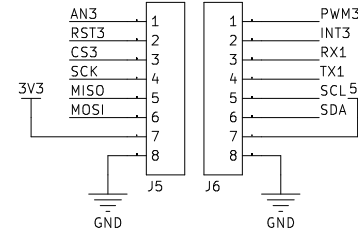

T3
TORNILLO

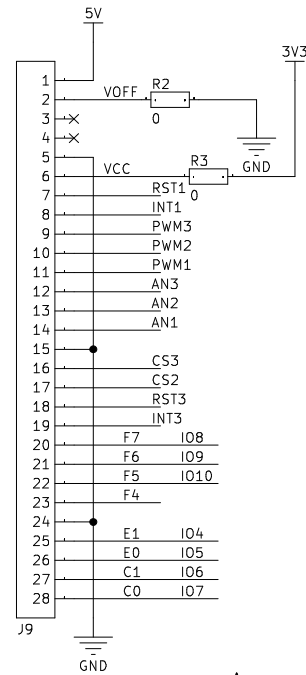
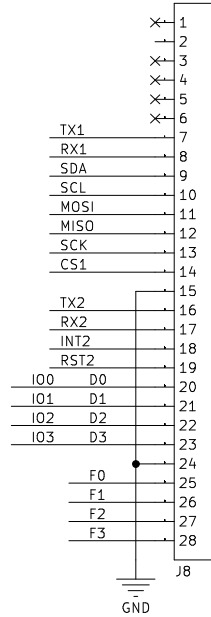

T4
TORNILLO

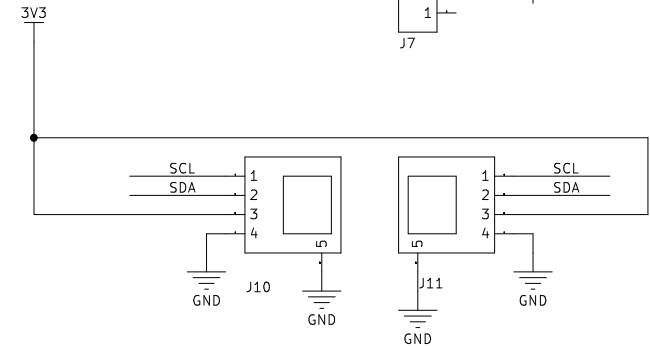
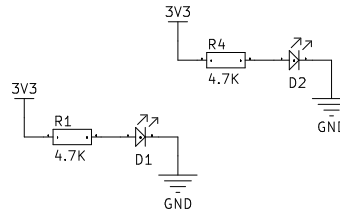

www.microside.com/xide

Microside Technology no asume responsabilidad alguna por errores o inexactitudes que puedan aparecer en el presente documento. Las especificaciones y la información contenidas en el presente esquemático están sujetas a cambios en cualquier momento sin previo aviso.

Title: X-BOARD CURIOSITY NANO

XB05
MICROSIDE TECHNOLOGY

Rev: R1
Date: 2022-06-20

X | B

