

T1
+
TORNILLO

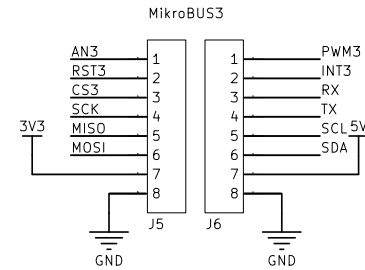

T2
+
TORNILLO

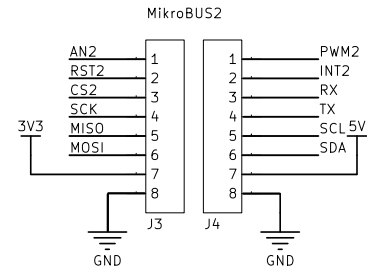
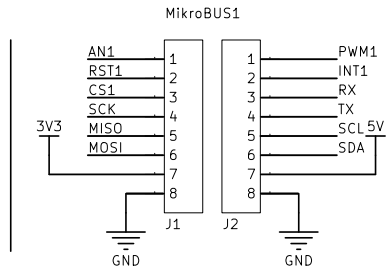
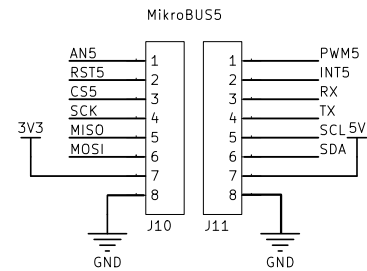
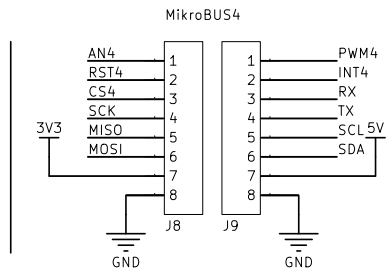

T3
+
TORNILLO

T4
+
TORNILLO

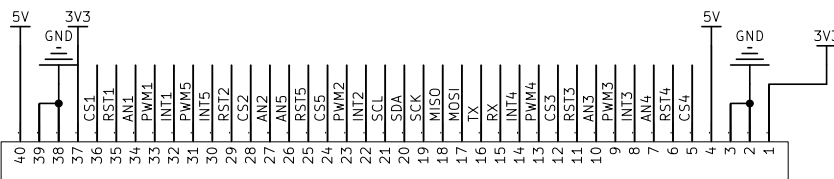
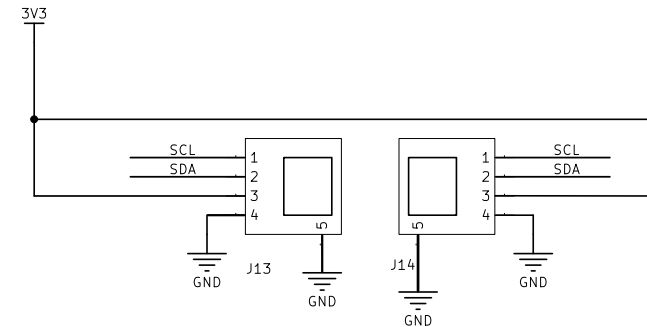
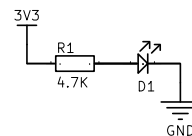
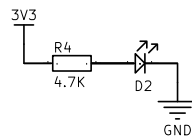

J7

www.microside.com/xide

Microside Technology no asume responsabilidad alguna por errores o inexactitudes que puedan aparecer en el presente documento. Las especificaciones y la información contenidas en el presente esquemático están sujetas a cambios en cualquier momento sin previo aviso.

Title: X-BOARD IoTrainer		
XB01		
MICROSIDE TECHNOLOGY		
Rev: R1		
Date: 2022-06-14		