

# **A8 mini**

## **4K AI MINI ZOOM GIMBAL CAMERA USER MANUAL**



**V1.2**

**Dec 2022**

Thank you for purchasing SIYI product.

A8 mini is a lightweight and elegant gimbal camera, carrying a 4K 1/1.7-inch Sony starlight night vision sensor, powerful AI identify, smart tracking feature based on neural network processing unit, and supports max 6X digital zoom. A8 mini's ethernet and HDMI output feature are compatible with both SIYI link and third-party link. And it supports CVBS (AV) output for analog FPV. A8 mini can be widely used for enterprise drones, UGV, USV, robotics, RC hobby planes and FPV drones.

To ensure you a good experience of the product, please read this manual carefully. If you encounter any issue using the product, please consult the manual or check the online pages of this product on SIYI official store (<https://shop.siyi.biz>). You can also write an email to SIYI official A/S center ([support@siyi.biz](mailto:support@siyi.biz)).

## SIYI User Group - Facebook



**SIYI Official Store** (<https://shop.siyi.biz>)

**SIYI Official AliExpress Store** (<https://siyi.aliexpress.com>)

**SIYI YouTube Channel** (<https://www.youtube.com/c/SIYITech>)

**CONTENT**

READ TIPS ..... 1

    Icons..... 1

    Safety..... 1

    Storage/Carrying/Recycling..... 2

1 INTRODUCTION ..... 3

    1.1 Product Features ..... 3

    1.2 Parts ..... 6

        1.2.1 At a Glance ..... 6

        1.2.2 Ports on A8 mini..... 8

    1.3 Technical Specification..... 10

    1.4 Packing List..... 12

    1.5 Indicator Definition ..... 13

2 GET READY TO USE A8 MINI ..... 14

    2.1 Installation ..... 14

    2.2 Connection and Power ..... 15

3 GIMBAL CONTROL ..... 16

    3.1 Control Gimbal Camera through SIYI FPV App with MK32 / MK15 Ground Station ..... 16

        3.1.1 Preparation..... 16

        3.1.2 Gimbal Pitch and Yaw Rotation ..... 17

        3.1.3 Zoom..... 18

        3.1.4 Take pictures and Record Video ..... 18

    3.2 Control Gimbal Camera through S.Bus Signal (Taking an Example of MK15) ..... 19

        3.2.1 Preparation..... 19

        3.2.2 Gimbal Pitch and Yaw Rotation (Taking an Example of MK15 Dials) ..... 22

        3.2.3 Zoom (Taking an Example of MK15 Switches) ..... 23

        3.1.4 Take Pictures and Record Video (Taking an Example of MK15 Buttons) ..... 23

    3.3 UART / UDP Control (through SDK) ..... 24

        3.3.1 SDK Protocol Format..... 24

        3.3.2 SDK Communication Commands..... 25

        3.3.3 ZR10 SDK Communication Interface..... 30

        3.3.4 ZR10 SDK Communication Code Examples ..... 31

3.3.5 SDK CRC16 Code .....	32
4 VIDEO OUTPUT .....	34
4.1 Output and Display Video Stream on MK15 Smart Controller .....	34
4.2 Output Video Stream through HM30 Full HD Image Transmission System .....	34
4.3 Output Video Stream to Third-Party Image Transmission Systems.....	36
4.4 Output A8 mini's Video Stream through HDMI .....	37
4.5 Output A8 mini's Video Stream by AV Signal .....	37
4.6 Solutions to No Image .....	38
4.6.1 Video Output to Android Device .....	39
4.6.2 Video Output to Windows Device.....	40
4.7 Common IP Addresses .....	41
5 SIYI FPV APP .....	43
5.1 Settings.....	45
5.2 Link Status.....	46
5.3 Gimbal Camera.....	47
5.4 About SIYI FPV.....	49
6 Firmware Upgrade and Configuration .....	50
6.1 Gimbal / Zoom Firmware Update.....	50
6.2 Camera Firmware Update.....	53
6.3 Gimbal Camera Configuration.....	54
6.3.1 Channel Settings.....	55
6.3.2 Camera Specs.....	56
7 After-sale Service .....	58
7.1 Repair Service .....	58
7.2 Warranty .....	59
7.2.1 7-Day Return & Refund.....	59
7.2.2 15-Day Replacement.....	60
7.2.3 1-Year Warranty Repair .....	62

## READ TIPS

### Icons

Please pay more attention to content indicated with the following marks:

 **DANGER** Dangerous manipulation probably leads to human injuries.

 **WARNING** Warnings on manipulation possibly leads to human injuries.

 **CAUTION** Cautions on what manipulation may lead to property loss.

 **Prohibited**    **Mandatory**    **Mark**

### Safety

A8 mini gimbal camera is designed for professional application in specific scenes, which has been done necessary configuration before delivery, it is forbidden to disassemble the gimbal or to change its mechanical structure. And don't add more payload to the gimbal other than its own camera. Gimbal camera is designed with very precise structure, users who approach to the equipment should have the basic knowledge of how to operate it. Irregular or irresponsible manipulations to the device may cause damage, property loss, or human injuries, and SIYI Technology is not obliged to any of the damage, loss, or injury. It is prohibited to use SIYI products for military purpose. Users under 14 years' old should follow an

experienced trainer's guide. Disassembling or modification to the system is prohibited without permission from its manufacturer, SIYI Technology.

## **Storage/Carrying/Recycling**

When your SIYI products are stand idle, or you are bringing it outdoors, or the system reached service life, then please do read the precautions below.



### **CAUTION**

Always place your SIYI products at places where babies or kids do not reach.



### **DANGER**

SIYI products should be placed in places with below conditions:

Not too hot (above 60°C) or too cold (under -20°C).

Not under direct sunshine or too dusty or too wet.

Not on an unstable holder which lacks solid supports or may cause vibration.

Not nearby steam or other heat sources.

# 1 INTRODUCTION

## 1.1 Product Features

### AI Smart Identify and Tracking

A8 mini gimbal camera carries a neural network processing unit (NPU), embedded in brand-new AI algorithms developed by SIYI. A8 mini can autonomously identify moving objects like vehicles, boats, and people. Companion with gimbal rotation and UAV flight control system, the gimbal camera will accomplish an overall smart operation from identifying and locating to continuously tracking. A8 mini's zoom camera will always maintain the tracking object in the center of the image.

*\*The AI feature is under development and will be supported by firmware update soon.*

### Powerful Imaging System

A8 mini gimbal camera comes with a 1/1.7-inch Sony image sensor, a megapixels CMOS with remarkable photosensitivity ability, impressive 4K video recording, and smooth 6X digital zooming. Those combined features make distant beautiful sceneries nicely seen in motion pictures.

### Upside Down Mode

A8 mini gimbal camera automatically activates upside down mode when it is placed upside down, very convenient to be mounted on multiple kinds of vehicles like UGV, USV, robot dog, and robotics.



## **Various Video Output, Ultra Low Latency**

A8 mini gimbal camera provides triple popular video output options, Ethernet, HDMI, and CVBS (AV). RC plane and FPV drone users can experience very low latency FPV through CVBS video output and analog image transmission system.

*\*A8 mini configured as ultra-low-latency mode, CVBS output to analog FPV transmitter, view from the monitor connected to FPV receiver, the overall latency is 60ms. Direct HDMI output from A8 mini to monitor, the latency is 65ms.*

## **Gimbal Motion Mode**

### **FPV Mode**

Gimbal rotates simultaneously as aircraft rolls to get FPV view, and output enhanced stable images, compatible with planes and racing drones especially for FPV scenes.

### **Follow Mode**

Horizontally, gimbal follows when aircraft rotates, compatible with multi-copter drones.

### **Lock Mode**

Horizontally, gimbal does not follow when aircraft rotates.

## **Starlight Night Vision Camera**

A8 mini gimbal camera's 1/1.7-inch ultra-sensitive starlight CMOS can keep image bright even in low light environment. HDR feature can precisely capture details of highlights and shadows in dynamic scenes, getting away of low light or backlight.

## **3-Axis Gimbal Stabilizing Control Algorithms**

### **High-Precision FOC Motor Control**

A8 mini gimbal camera is applied with industry-level 3-axis stabilizing technology and high-precision FOC control algorithms, which reduces most image shaking and ensure image is always stable even if aircraft or vehicle is vigorously moving. Meanwhile, camera continuously outputs smooth and clear images even in zooming.

## 1.2 Parts

### 1.2.1 At a Glance



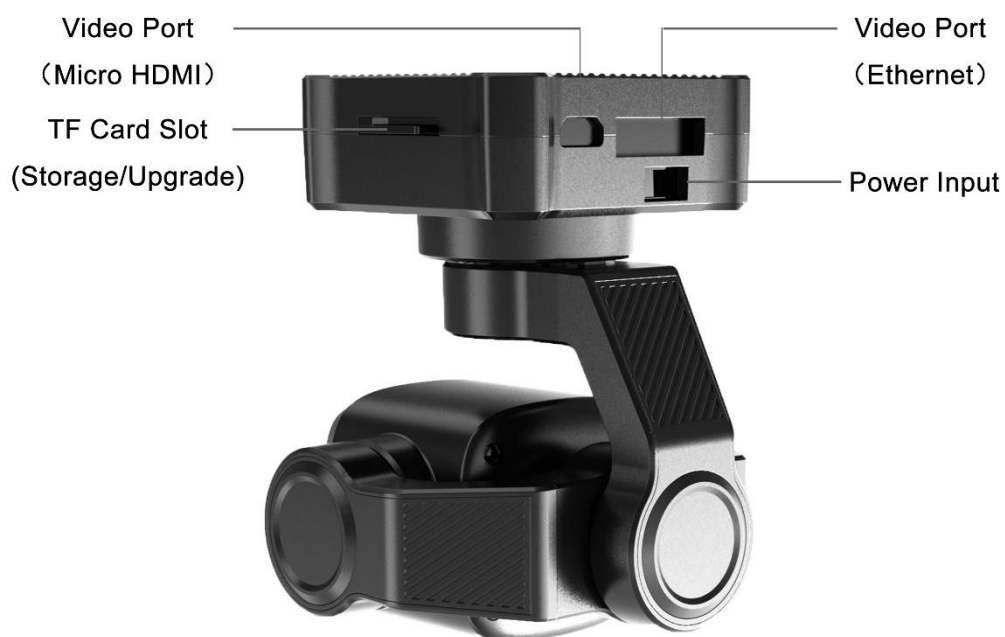

## 1.2.2 Ports on A8 mini

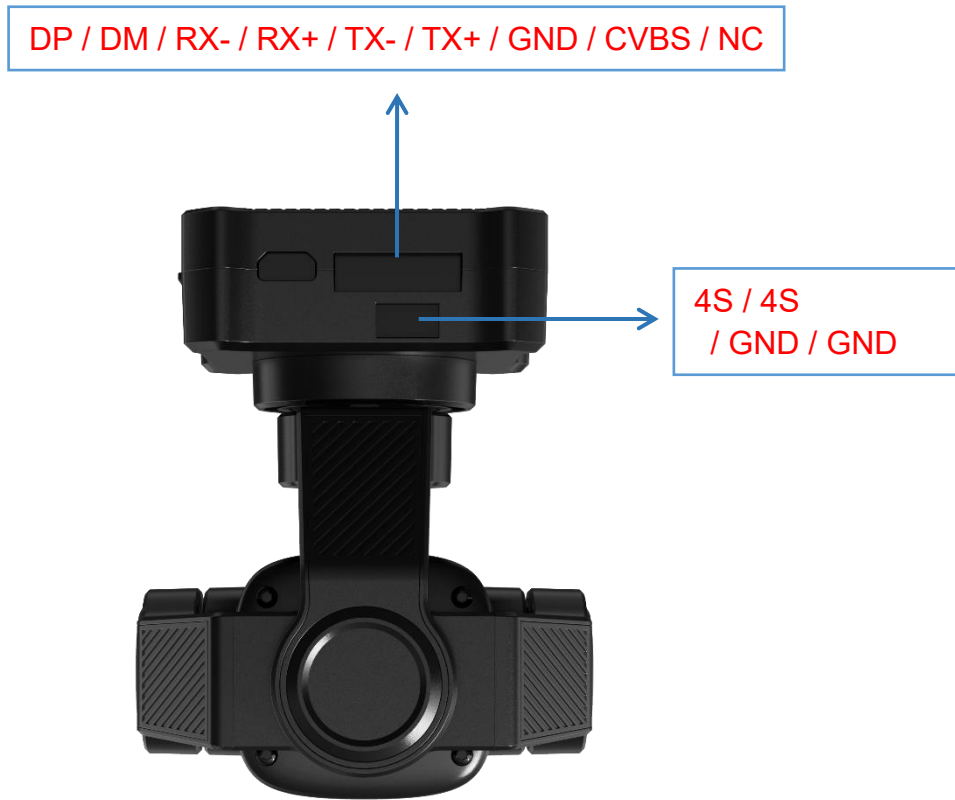

RX / TX / GND / S.Bus IN / S.Bus OUT



## 1.3 Technical Specification

### Overall

<b>Video Output Port</b>	Ethernet, HDMI, CVBS(AV)
<b>Control Signal Input Port</b>	S.Bus / UART / UDP
<b>Control Signal Output Port</b>	S.Bus
<b>Working Voltage</b>	14.8 V
<b>Power Consumption</b>	Summit 12 W
<b>Working Temperature</b>	-10 ~ 50 °C
<b>Dimension</b>	55 x 55 x 70 mm
<b>Weight</b>	Approx. 95 g

### Gimbal

<b>Angular Vibration Range</b>	$\pm 0.01^\circ$
<b>Controllable Pitch Angle</b>	-135° ~ +45°
<b>Controllable Yaw Angle</b>	-160° ~ +160°
<b>Controllable Roll Angle</b>	-30° ~ +30°

### Camera

<b>Lens</b>	6X Digital
<b>Focal Length</b>	21 mm
<b>Image Sensor</b>	Sony 1/1.7-inch, 8 MP effective resolution
<b>Aperture</b>	F2.8
<b>FOV</b>	93°

<b>TF Card Recording Resolution</b>	4K (4096 x 2160) @ 25 fps 2K (2560 x 1440) @ 30 fps 1080p (1920 x 1080) @ 30 fps 720p (1280 x 720) @ 30 fps
<b>Supported File System</b>	FAT32 (exFAT will be supported later by firmware update)
<b>Photography File Format</b>	JPG
<b>Video File Format</b>	MP4
<b>Supported TF Card Type</b>	MicroSD Class10, max 128 GB
<b>Still Photography Mode</b>	Single
<b>White Balance</b>	Auto











## **1.4 Packing List**

- 1 x A8 mini Gimbal Camera
- 1 x Gimbal Control Signal Cable
- 1 x Power Cable
- 1 x SIYI Video Cable
- 1 x Universal Video Cable
- 1 x Ethernet to RJ45 Cable
- 1 x S.Bus Y cable
- 6 x Hex Socket Cap Screw M2.5\*6
- 10 x Cross Recessed Flat Head Screw M2.5\*10
- 8 x M2.5 Nut Black

## 1.5 Indicator Definition

The status indicators on A8 mini gimbal camera use three different colors and different blinking frequencies to indicate the system's working or abnormal status.

-  Solid Green: Normally working.
-  Slow Green Blinks: S.Bus signal input is normal.
-  Slow Red Blinks: Firmware does not match (camera firmware or gimbal firmware or neither).
-  Red-Red-Yellow Blinks Continuously: Fail to identify camera board.
-  Yellow Blinks: Power input voltage is low (lower than 10 V).
-  Double Red Blinks: IMU temperature rising is abnormal.
-  Double Yellow Blinks: IMU temperature is rising.
-  Triple Yellow Blinks: IMU temperature is abnormal.

## 2 GET READY TO USE A8 MINI

### 2.1 Installation

Screw Holes' Position and Distance

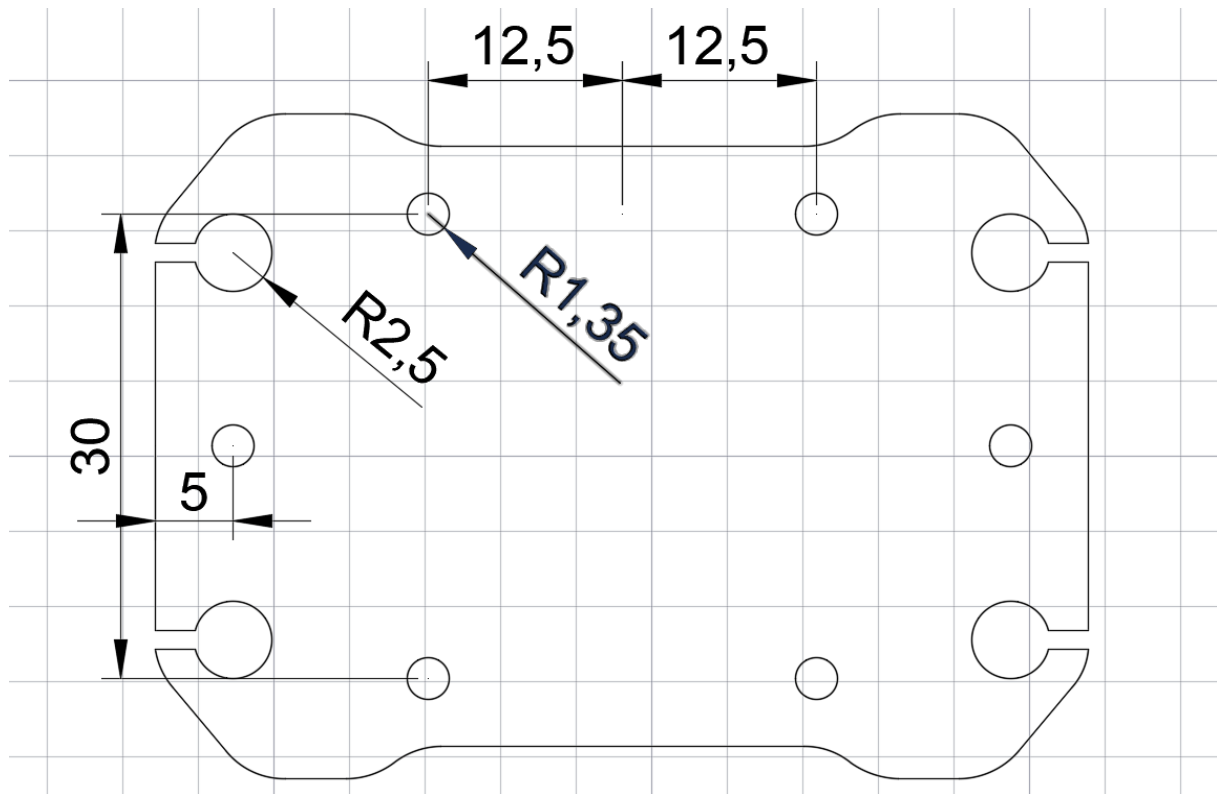

#### Mark

Welcome to contact SIYI to get the 3D file of A8 mini gimbal camera for pre-installation.

## 2.2 Connection and Power

A8 mini gimbal camera can be powered in many ways. If you plan to carry A8 mini by your plane and the plane may roll in a wide margin, then please use connect A8 mini's power port directly by a 4S power battery, not through power distribution board or air unit.

## 3 GIMBAL CONTROL

A8 mini gimbal camera supports multiple methods to control.

### 3.1 Control Gimbal Camera through SIYI FPV App with MK32 / MK15 Ground Station

Gimbal camera can connect to air unit directly, then you can control gimbal rotation, gimbal functions, and display video in SIYI FPV app on screen after binding it with the air unit.

#### 3.1.1 Preparation

It is necessary to prepare the tools, firmware, and software below before controlling gimbal camera in this way.

- MK32 / MK15 Handheld Ground Station (MK32 / MK15 standard combo is suggested for using conveniently with A8 mini gimbal camera)
- A8 mini Gimbal Camera

#### **Mark**

Above products can be purchased from SIYI directly or from SIYI authorized dealers.

- A8 mini SIYI Video Cable

## Mark

Above tools come with gimbal camera package.

- SIYI FPV App (v2.5.8.470 or latest version)

## Mark

Above software can be downloaded from relevant product page on SIYI official website.

### Steps

1. Power air unit and bind it with ground station.
2. Use SIYI Video Cable to connect the air unit's video port with the gimbal camera's video port.
3. Update SIYI FPV app.
4. Run SIYI FPV app, go to "Settings – Camera A8 mini", and select "SIYI Camera 1" (when IP addresses are 192.168.144.25) or "SIYI Camera 2" (when IP addresses are 192.168.144.26), video stream will display. Gimbal motion and camera functions can be controlled by ground station touchscreen.

### 3.1.2 Gimbal Pitch and Yaw Rotation

While SIYI FPV App is running, sliding on touchscreen can control gimbal motion.

Sliding left and right are yaw rotation, up and down are pitch rotation.

Double tap touchscreen, gimbal will automatically center.

## **Mark**

Slide on touchscreen and hold it, gimbal will continue rotating till it reaches physical limit.

Farther that you hold it from the center of the screen, faster the gimbal rotates.

### **3.1.3 Zoom**

Touching “Zoom in” or “Zoom out” icon on SIYI FPV app can control camera image zooming, up to 6X digital.

### **3.1.4 Take pictures and Record Video**

Touch “Photo” icon once on SIYI FPV app to take a picture. Touch “Record” icon to start video recording. Touch “Recording” icon to stop video recording.

## **Mark**

Before taking a picture or recording video, it is necessary to insert TF/SD card into the camera.

## 3.2 Control Gimbal Camera through S.Bus Signal (Taking an Example of MK15)

A8 mini can be connected to MK15 air unit for gimbal and camera control through joysticks, dials, switches, and buttons on MK15 remote controller after binding.

### 3.2.1 Preparation

It is necessary to prepare the below tools, firmware, and software before controlling gimbal camera in this way.

- MK15 Mini HD Handheld Smart Controller (Enterprise standard combo is suggested for conveniently using with A8 mini)
- A8 mini Gimbal Camera

#### Mark

Above products can be purchased from SIYI directly or from SIYI authorized dealers.

- SIYI Video Cable
- Gimbal Control Signal Cable
- S.Bus Y Cable

#### Mark



Above tools come with gimbal camera package.

- Cable (USB-C to USB-A)

### **Mark**

Above tools should be prepared by customer.

- SIYI PC Assistant (v1.3.2 or latest version)

### **Mark**

Above software can be downloaded from relevant product page on SIYI official website.

## **Steps**

1. Power MK15 air unit and bind it with MK15 remote controller.
2. Use SIYI Video Cable to connect MK15 air unit's video port with A8 mini gimbal camera's video port.
3. Put the Gimbal Control Signal Cable together with the S.Bus Y Cable by connecting them.
4. Then use the combined cable to connect MK15 air unit's RC port and A8 mini gimbal camera's control signal port.
5. Install and run SIYI PC Assistant on Windows computer.
6. Use the USB-C to USB-A cable to connect A8 mini gimbal camera with Windows

computer, then run SIYI PC Assistant and go to “Gimbal Config” page.

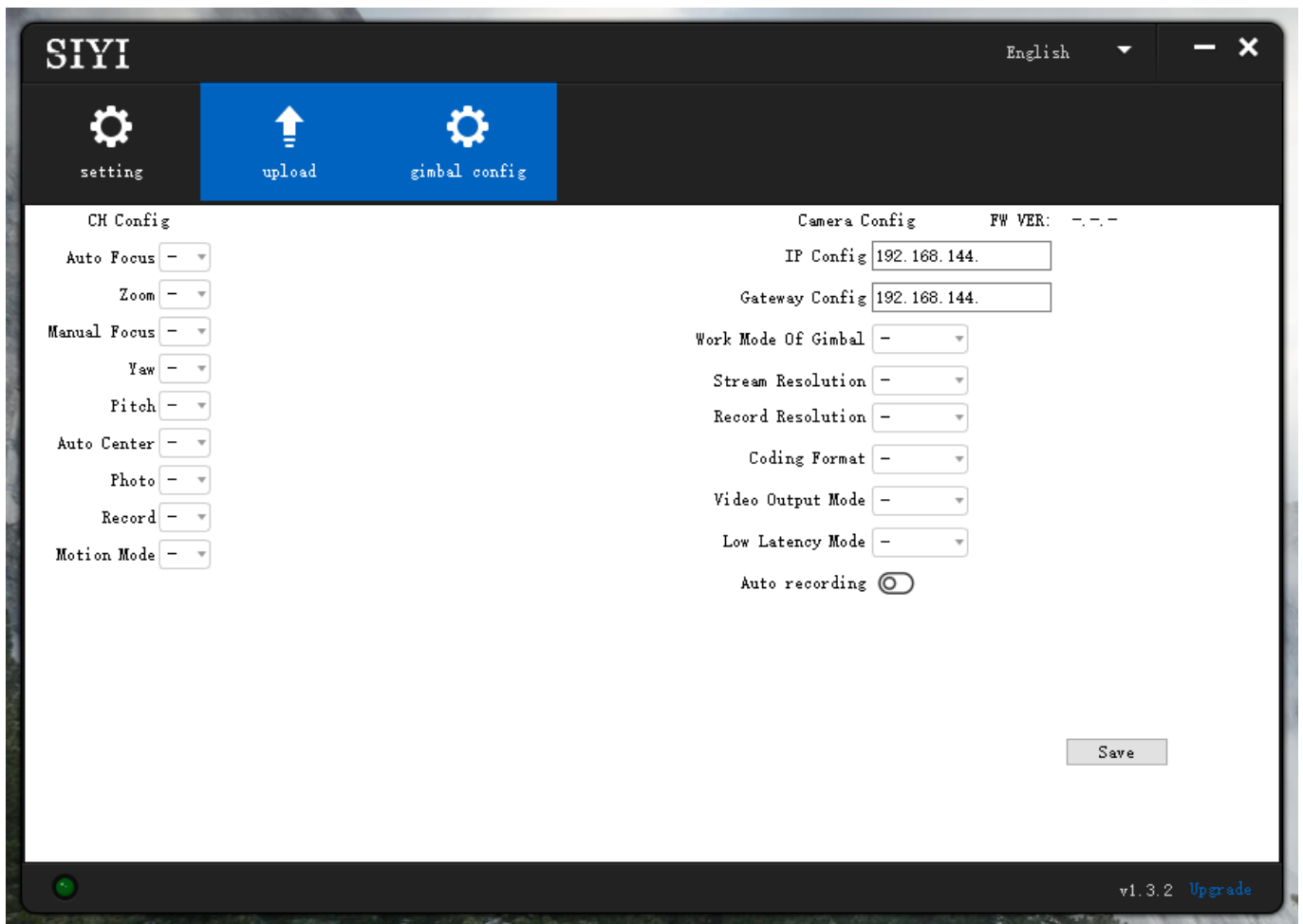

7. Under “Channel Config” menu, assign remote controller channel 1 to 16 to target gimbal / camera functions according to your requirement.
8. For the assigned channels, operate their mapped joysticks, dials, switches, and buttons on MK15 remote controller to confirm if they are working normally.

### Mark

A8 mini gimbal camera does not come with focus feature.

### 3.2.2 Gimbal Pitch and Yaw Rotation (Taking an Example of MK15 Dials)

Below are the MK15 channel mapping settings for gimbal testing, customers are free to assign MK15 channel mappings as required through SIYI TX app.

- Channel 7 = Left Dial (Reversed)
- Channel 8 = Right Dial
- Channel 12 = Button D

In SIYI PC Assistant, map “Yaw” function to channel 7 and “Pitch” to channel 8, “Center” to channel 12.

Then, if you operate the left dial on MK15 remote controller, gimbal will rotate around yaw axis. If you operate the right dial, gimbal will rotate around pitch axis. Press button D, gimbal will center automatically.

#### **Mark**

Hold the dial from its center position, gimbal will rotate till reaching limit. Farther that you hold it away from center screen, faster gimbal rotates.

### 3.2.3 Zoom (Taking an Example of MK15 Switches)

Below are the MK15 channel mapping settings for gimbal testing, customers are free to assign MK15 channel mappings as required through SIYI TX app.

- Channel 13 = Left Switch SA

In SIYI PC Assistant, map “Zoom” function to channel 13.

Then, if you operate the SA switch on MK15 remote controller, camera will zoom in or zoom out digitally from 1X to 6X.

### 3.1.4 Take Pictures and Record Video (Taking an Example of MK15 Buttons)

Below are the MK15 channel mapping settings for gimbal testing, customers are free to assign MK15 channel mappings as required through SIYI TX app.

- Channel 9 = Button A
- Channel 10 = Button B

In SIYI PC Assistant, map “Photo” function to channel 9 and “Record” to channel 10.

Then, if you press button A on MK15 remote controller, camera will take a picture. If you press button B, camera will start or stop video recording.

## Mark

Before taking pictures or recording video, it is necessary to insert SD / TF card into the camera.

### 3.3 UART / UDP Control (through SDK)

A8 mini gimbal camera provides control and function protocol for all customers, please refer to the below file “SIYI Gimbal Camera SDK Communication Protocol” for secondary development.

#### 3.3.1 SDK Protocol Format

Field	Index	Bytes	Description
STX	0	2	0x6655: starting mark <b>Low byte in the front</b>
CTRL	2	1	0: need_ack (if the current data pack need “ack”) 1: ack_pack (if the current data pack is an “ack” package) 2-7: reserved
Data_len	3	2	Date field byte length <b>Low byte in the front</b>
SEQ	5	2	Frame sequence (0 ~ 65535) <b>Low byte in the front</b>
CMD_ID	7	1	Command ID
DATA	8	Data_len	Data
CRC16		2	CRC16 check to the complete data package. <b>Low byte in the front</b>

### 3.3.2 SDK Communication Commands

#### Acquire Firmware Version

CMD_ID:0x01-----Acquire Firmware Version			
Send data format			
No.	Data Type	Data Name	Description
ACK data format			
	uint32_t	code_board_ver	Camera firmware version
	uint32_t	gimbal_firmware_ver	Gimbal firmware version
	uint32_t	zoom_firmware_ver	Zoom firmware version

Eg: 0x6E030203--> firmware version v3.2.3

Mark:

1. Ignore the 4<sup>th</sup> byte (higher byte)
2. Zoom firmware version is only available for ZR10 at this moment.

#### Acquire Hardware ID

CMD_ID:0x02----- Hardware ID			
Send data format			
No.	Data Type	Data Name	Description
ACK data format			
	Uint8_t	hardware_id[12]	Hardware ID character string (10 digits)

#### Auto Focus

CMD_ID:0x04-----Auto Focus			
Send data format			
No.	Data Type	Data Name	Description
1	uint8_t	auto_focus	1: Start auto focus for once
ACK data format			
1	uint8_t	sta	1: Success 0: Fail

#### Manual Zoom and Auto Focus

CMD_ID:0x05-----Manual Zoom and Auto Focus			
--	--	--	--

Send data format			
No.	Data Type	Data Name	Data Description
1	int8_t	zoom	1: Start zooming in 0: Stop zooming in / out (send when released from control command) -1: Start zooming out
ACK data format			
	uint16_t	zoom_multiple	Current (hybrid) zoom multiples, (zoom_multiple / 10, accurate to one decimal point)

## Manual Focus

CMD_ID:0x06-----Manual Focus			
Send data format			
No.	Data Type	Data Name	Description
1	int8_t	focus	1: Long shot 0: Stop manual focus (send when released from control command) -1: Close shot
ACK data format			
	uint8_t	sta	1: Success 0: Fail

Mark:

Only available on ZR10 at this moment.

## Gimbal Rotation

CMD_ID:0x07-----Gimbal Rotation			
Send data format			
No.	Date Type	Date Name	Description
1	int8_t	turn_yaw	-100~0~100: Negative and positive represent two directions, higher or lower the number is away from 0, faster the rotation speed is. Send 0 when released from control command and gimbal stops rotation.
2	int8_t	turn_pitch	-100~0~100: Same as above
ACK data format			
	uint8_t	sta	1: Success 0: Fail

## Center

CMD_ID:0x08-----Center			
Send data format			
No.	Data Type	Data Name	Description
1	uint8_t	center_pos	1: gimbal centers to position 0
ACK data format			
1	uint8_t	sta	1: Success 0: Fail



## Acquire Gimbal Configuration Information

CMD_ID:0x0A-----Acquire Gimbal Configuration Information			
Send data format			
No.	Data Type	Data Name	Description
ACK data format			
1	uint8_t	reserved	
2	uint8_t	hdr_sta	0: HDR OFF 1: HDR ON
3	uint8_t	reserved	
4	uint8_t	record_sta	0: Recording OFF 1: Recording ON 2: TF card slot is empty 3: (Recording) Data loss in TF card recorded video, please check TF card
5	uint8_t	gimbal_motion_mode	0: Lock Mode 1: Follow Mode 2: FPV Mode
6	uint8_t	gimbal_mounting_dir	Gimbal Mounting Method 0: Reserved 1: Normal 2: Upside Down
7	uint8_t	video_hdmi_or_cvbs	(Only available on A8 mini) Video output status of HDMI and CVBS: 0: HDMI output ON CVBS output OFF 1: HDMI output OFF CVBS output ON

## Function Feedback Information

CMD_ID:0x0B-----Function Feedback Information			
Send data format			
No.	Data Type	Data Name	Description
ACK data format			
1	uint8_t	info_type	0: Success 1: Fail to take a photo (Please check if TF card is inserted) 2: HDR ON

			3: HDR OFF 4: Fail to record a video (Please check if TF card is inserted)
--	--	--	---

## Photo and Video

CMD_ID:0x0C-----Photo			
Send data format			
No.	Data Type	Data Name	Description
	uint8_t	func_type	0: Take a picture 1: Switch on / off HDR (not supported yet) 2: Start / Stop Recording 3: Motion – Lock Mode 4: Motion – Follow Mode 5: Motion – FPV Mode 6: Set video output as HDMI (Only available on A8 mini, restart gimbal to take effect) 7: Set video output as CVBS (Only available on A8 mini, restart gimbal to take effect) 8: Turn off both HDMI and CVBS video output (Only available on A8 mini, restart gimbal to take effect)
ACK data format			
			No ack

## Acquire Gimbal Attitude

CMD_ID:0x0D-----Acquire Gimbal Attitude			
Send data format			
No.	Data Type	Data Name	Description
ACK data format			
	int16_t	yaw	Yaw axis degree
	int16_t	pitch	Pitch axis degree
	int16_t	roll	Roll axis degree
	int16_t	yaw_velocity	Yaw axis rotation speed
	int16_t	pitch_velocity	Pitch axis rotation speed
	int16_t	roll_velocity	Roll axis rotation speed

Mark:

The above data to be divided by 10 is the actual degree, accuracy in one decimal place.

## Set Gimbal Control Angle

CMD_ID:0x0D-----Set Gimbal Control Angle			
Send data format			
No.	Data Type	Data Name	Description
	int16_t	yaw	Target yaw angle
	int16_t	pitch	Target pitch angle
ACK data format			
	int16_t	yaw	Current yaw angle
	int16_t	pitch	Current pitch angle
	int16_t	roll	Current roll angle

### Angle Control Range

Yaw:

- A8 mini: -135.0 ~ 135.0 degree
- ZR10: Same with A8 mini

Pitch

- A8 mini: -90.0 ~ 25.0 degree
- ZR10: Same with A8 mini

Mark:

The accuracy of the control angle is in one decimal place. Eg: Set yaw as 60.5 degrees, the command number should be set as 605.

The actual angle data returned to be divided by 10 is the actual degree, accuracy in one decimal place.

## 3.3.3 ZR10 SDK Communication Interface

### TTL Serial Port

- Baud rate: 115200
- Data position: 8 digits. Stop position: 1 digit. No check.

### UDP

- IP: 192.168.144.25
- Port Number: 37260

### 3.3.4 ZR10 SDK Communication Code Examples

Zoom 1

55 66 01 01 00 00 00 05 01 8d 64

Zoom -1

55 66 01 01 00 00 00 05 FF 5c 6a

Manual Focus 1

55 66 01 01 00 00 00 06 01 de 31

Manual Focus -1

55 66 01 01 00 00 00 06 ff 0f 3f

Take Pictures

55 66 01 01 00 00 00 0c 00 34 ce

Record Video

55 66 01 01 00 00 00 0c 02 76 ee

Rotate 100 100

55 66 01 02 00 00 00 07 64 64 3d cf

Auto Centering

55 66 01 01 00 00 00 08 01 d1 12

Gimbal Status Information

55 66 01 00 00 00 00 0a 0f 75

Auto Focus

55 66 01 01 00 00 00 04 01 bc 57

Acquire Hardware ID

55 66 01 00 00 00 00 02 07 f4

Acquire Firmware Version

55 66 01 00 00 00 00 01 64 c4

Lock Mode

55 66 01 01 00 00 00 0c 03 57 fe

Follow Mode

55 66 01 01 00 00 00 0c 04 b0 8e

FPV Mode

55 66 01 01 00 00 00 0c 05 91 9e

Acquire Attitude Data

55 66 01 00 00 00 00 0d e8 05

Set Video Output as HDMI (Only available on A8 mini, restart to take effect)

55 66 01 01 00 00 00 0c 06 f2 ae

Set Video Output as CVBS (Only available on A8 mini, restart to take effect)

55 66 01 01 00 00 00 0c 07 d3 be

Turn Off both CVBS and HDMI Output (Only available on A8 mini, restart to take effect)

55 66 01 01 00 00 00 0c 08 3c 4f

### 3.3.5 SDK CRC16 Code

```
const uint16_t crc16_tab[256];
/*****
CRC16 Coding & Decoding G(X) = X^16+X^12+X^5+1
*****/
uint16_t CRC16_cal(uint8_t *ptr, uint32_t len, uint16_t crc_init)
{
    uint16_t crc,   oldcrc16;
    uint8_t  temp;
    crc = crc_init;
    while (len--!=0)
    {
        temp=(crc>>8)&0xff;
        oldcrc16=crc16_tab[*ptr^temp];
        crc=(crc<<8)^oldcrc16;
        ptr++;
    }
    //crc=~crc;    //??
    return(crc);
}

uint8_t crc_check_16bites(uint8_t* pbuf, uint32_t len, uint32_t* p_result)
{
```

```

uint16_t crc_result = 0;
crc_result= CRC16_cal(pbuf,len, 0);
*p_result = crc_result;

return 2;
}

const uint16_t crc16_tab[256]= {0x0,0x1021,0x2042,0x3063,0x4084,0x50a5,0x60c6,0x70e7,
                                0x8108,0x9129,0xa14a,0xb16b,0xc18c,0xd1ad,0xe1ce,0xf1ef,
                                0x1231,0x210,0x3273,0x2252,0x52b5,0x4294,0x72f7,0x62d6,
                                0x9339,0x8318,0xb37b,0xa35a,0xd3bd,0xc39c,0xf3ff,0xe3de,
                                0x2462,0x3443,0x420,0x1401,0x64e6,0x74c7,0x44a4,0x5485,
                                0xa56a,0xb54b,0x8528,0x9509,0xe5ee,0xf5cf,0xc5ac,0xd58d,
                                0x3653,0x2672,0x1611,0x630,0x76d7,0x66f6,0x5695,0x46b4,
                                0xb75b,0xa77a,0x9719,0x8738,0xf7df,0xe7fe,0xd79d,0xc7bc,
                                0x48c4,0x58e5,0x6886,0x78a7,0x840,0x1861,0x2802,0x3823,
                                0xc9cc,0xd9ed,0xe98e,0xf9af,0x8948,0x9969,0xa90a,0xb92b,
                                0x5af5,0x4ad4,0x7ab7,0x6a96,0x1a71,0xa50,0x3a33,0x2a12,
                                0xdbfd,0xcdbc,0xfbbf,0xeb9e,0x9b79,0x8b58,0xbb3b,0xab1a,
                                0x6ca6,0x7c87,0x4ce4,0x5cc5,0x2c22,0x3c03,0xc60,0x1c41,
                                0xedaе,0xfd8f,0xcdec,0xddcd,0xad2a,0xbd0b,0x8d68,0x9d49,
                                0x7e97,0x6eb6,0x5ed5,0x4ef4,0x3e13,0x2e32,0x1e51,0xe70,
                                0xff9f,0xefbe,0xdfdd,0xcffc,0xbf1b,0xaf3a,0x9f59,0x8f78,
                                0x9188,0x81a9,0xb1ca,0xa1eb,0xd10c,0xc12d,0xf14e,0xe16f,
                                0x1080,0xa1,0x30c2,0x20e3,0x5004,0x4025,0x7046,0x6067,
                                0x83b9,0x9398,0xa3fb,0xb3da,0xc33d,0xd31c,0xe37f,0xf35e,
                                0x2b1,0x1290,0x22f3,0x32d2,0x4235,0x5214,0x6277,0x7256,
                                0xb5ea,0xa5cb,0x95a8,0x8589,0xf56e,0xe54f,0xd52c,0xc50d,
                                0x34e2,0x24c3,0x14a0,0x481,0x7466,0x6447,0x5424,0x4405,
                                0xa7db,0xb7fa,0x8799,0x97b8,0xe75f,0xf77e,0xc71d,0xd73c,
                                0x26d3,0x36f2,0x691,0x16b0,0x6657,0x7676,0x4615,0x5634,
                                0xd94c,0xc96d,0xf90e,0xe92f,0x99c8,0x89e9,0xb98a,0xa9ab,
                                0x5844,0x4865,0x7806,0x6827,0x18c0,0x8e1,0x3882,0x28a3,
                                0xcb7d,0xdb5c,0xeb3f,0xfb1e,0x8bf9,0x9bd8,0xabbb,0xbb9a,
                                0x4a75,0x5a54,0x6a37,0x7a16,0xaf1,0x1ad0,0x2ab3,0x3a92,
                                0xfd2e,0xed0f,0xdd6c,0xcd4d,0xbdaa,0xad8b,0x9de8,0x8dc9,
                                0x7c26,0x6c07,0x5c64,0x4c45,0x3ca2,0x2c83,0x1ce0,0xcc1,
                                0xef1f,0xff3e,0xcf5d,0xdf7c,0xaf9b,0xbfba,0x8fd9,0x9ff8,
                                0x6e17,0x7e36,0x4e55,0x5e74,0x2e93,0x3eb2,0xed1,0x1ef0
};

```

## 4 VIDEO OUTPUT

A8 mini gimbal camera comes with three video output methods: Ethernet, HDMI, and CVBS(AV).

### **Mark**

The default video output method of A8 mini gimbal is Ethernet. When “Video Output” option is set as “OFF” in SIYI FPV app, A8 mini’s Ethernet video output will get the best performance.

### **4.1 Output and Display Video Stream on MK15 Smart Controller**

A8 mini gimbal camera can connect to MK15 air unit directly, then video will be displayed in SIYI FPV app after binding MK15 air unit to MK15 remote controller. Please refer to Chapter 3.1 in this manual for details.

### **4.2 Output Video Stream through HM30 Full HD Image Transmission System**

A8 mini gimbal camera can connect to HM30 air unit directly, then the video will be displayed in SIYI FPV app or other methods that HM30 supports after binding HM30 air unit to HM30 ground unit.

## Preparation

It is necessary to prepare the tools, firmware, and software below before outputting video stream in this way.

- HM30 Full HD Image Transmission System
- A8 mini Gimbal Camera

### Mark

Above products can be purchased from SIYI directly or from SIYI authorized dealers.

- SIYI Video Cable

### Mark

Above tools come with A8 mini package.

- SIYI FPV App (v2.5.8.470 or latest version)

### Mark

Above software can be downloaded from relevant product page on SIYI official website.

## Steps

1. Power HM30 air unit and bind it with HM30 ground unit.



2. Use SIYI Video Cable to connect HM30 air unit's video port with A8 mini gimbal camera's video port.
3. Update SIYI FPV App on your Android device to latest version.
4. Run SIYI FPV app, go to "Settings – Camera A8 mini", and select "SIYI Camera 1" (when IP addresses are 192.168.144.25) or "SIYI Camera 2" (when IP addresses are 192.168.144.26), then it will display video stream. Gimbal rotation and camera functions can be controlled by Android device touchscreen.

### 4.3 Output Video Stream to Third-Party Image Transmission Systems

SIYI gimbal cameras can output video stream to any third-party image transmission systems which provide Ethernet port and are compatible with RTSP video stream.

In this way, it is necessary to prepare a customized video cable for connection between SIYI gimbal camera and the third-party image transmission system.

#### **CAUTION**

A8 mini video port's "RX-" pinout should connect to the image transmission system video port's "RX-" pinout, and "RX+" pinout to "RX+" pinout. Do not cross the pinouts, otherwise it will cause damage to the device.

SIYI gimbal cameras' working voltage is from 14.8 V, please make sure that the power voltage input is in the range before wiring.

## Steps

1. Power the air unit of the image transmission system and bind it with the ground unit.
2. Use the video cable to connect SIYI gimbal camera's video output port and the image transmission system's video input port.
3. Open RTSP video player and input SIYI gimbal camera's RTSP addresses (rtsp://192.168.144.25:8554/main.264), if video displays normally, connection is successful.

## 4.4 Output A8 mini's Video Stream through HDMI

A8 mini can output video stream to any HDMI monitor through the HDMI port.

### Mark

The default video output method of A8 mini is Ethernet.

Go to the “Camera A8 mini” settings in SIYI FPV app and switch video output mode to “HDMI”, then A8 mini video stream will go through the Micro HDMI port.

## 4.5 Output A8 mini's Video Stream by AV Signal

A8 mini can output video stream by AV signal through the Ethernet video output port.

 **Mark**

The default video output method of A8 mini is Ethernet.

Go to the “Camera A8 mini” settings in SIYI FPV app and switch video output mode to “CVBS”, then A8 mini video stream will output as AV signal through the Ethernet video output port.

## 4.6 Solutions to No Image

If SIYI gimbal camera failed to output video or the video stream cannot be displayed properly, please follow the steps below to investigate possible reasons.

1. Confirm if the image transmission system ground unit is bound with the air unit and if camera is connected to the air unit.
2. Check Camera IP addresses and RTSP addresses.

If video stream still does not display, please follow the steps below and make a deep investigation according to the video output mode and the video display device you use.

### 4.6.1 Video Output to Android Device

1. Input SIYI gimbal camera's default IP addresses "192.168.144.25" in the "Ping Tools" app and check if the network communication is successful. If there is a response, then check if the RTSP address in the video player is correct.



#### Successful Network Communication



#### Network Communication Failed

2. If the network communication is failed, then please check if the communication between the image transmission system's ground unit and the air unit is

successful. If it is, then please check if the video cable between camera and image transmission system's air unit is good, and if the voltage input is in normal range.

#### 4.6.2 Video Output to Windows Device

1. Use the "Win + R" key combo to wake up the "Run" program and input the command "cmd".

```

C:\Windows\system32\cmd.exe
Microsoft Windows [版本 10.0.19042.804]
(c) 2020 Microsoft Corporation. 保留所有权利。

C:\Users\Administrator>ping 192.168.144

正在 Ping 192.168.0.144 具有 32 字节的数据:
Control-C
^C
C:\Users\Administrator>ping 192.168.144.25

正在 Ping 192.168.144.25 具有 32 字节的数据:
来自 192.168.144.25 的回复: 字节=32 时间=9ms TTL=64
来自 192.168.144.25 的回复: 字节=32 时间=3ms TTL=64
来自 192.168.144.25 的回复: 字节=32 时间=4ms TTL=64
来自 192.168.144.25 的回复: 字节=32 时间=3ms TTL=64
    
```

Successful Network Communication

```

C:\Windows\system32\cmd.exe

正在 Ping 192.168.144.25 具有 32 字节的数据:
Control-C
^C
C:\Users\Administrator>ping 192.168.144.25

正在 Ping 192.168.144.25 具有 32 字节的数据:
请求超时。
请求超时。
来自 192.168.144.153 的回复: 无法访问目标主机。
来自 192.168.144.153 的回复: 无法访问目标主机。

192.168.144.25 的 Ping 统计信息:
    数据包: 已发送 = 4, 已接收 = 2, 丢失 = 2 (50% 丢失),
C:\Users\Administrator>
    
```

Network Communication Failed

- Input the ZR10 gimbal camera's default IP addresses "192.168.144.25" and press the "Enter" key to check if communication is successful. If it is successful, please check if the RTSP addresses in the RTSP player is correct or try to switch to other video players.



- If the network communication is failed, then please check if the communication between the image transmission system's ground unit and the air unit is successful. If it is, then please check if the video cable between camera and image transmission system's air unit is good, and if the voltage input is in normal range.

## Mark

If you have done investigation by following all steps above, but the reason is still not located, please contact your dealer or contact SIYI Support immediately.

## 4.7 Common IP Addresses

SIYI Gimbal Camera's Default IP Addresses: 192.168.144.25

SIYI Gimbal Camera's Default RTSP Addresses:

rtsp://192.168.144.25:8554/main.264

SIYI FPV App's "SIYI Camera 1" IP Addresses: 192.168.144.25

SIYI FPV App's "SIYI Camera 2" IP Addresses: 192.168.144.26

## 5 SIYI FPV APP

SIYI FPV is an Android application developed by SIYI to configure multiple SIYI devices for image transmission settings, camera settings, video stream display, and link status monitor.

### **Mark**

The manual is edited based on SIYI FPV App v2.5.470.

SIYI FPV App can be download from the SIYI official links.

SIYI FPV App compatible SIYI devices.

- A2 mini Ultra-Wide-Angle FPV Gimbal
- MK32 Enterprise Handheld Ground Station
- A8 mini AI Mini Zoom Gimbal Camera
- ZR10 2K QHD 30X Hybrid Zoom Gimbal Camera
- R1 / R1M HD Recording FPV Camera
- Air Unit HDMI Input Converter
- HM30 Full HD Image Transmission System
- MK15 / MK15E Mini HD Handheld Smart Controller



## SIYI FPV App OSD Information Definition

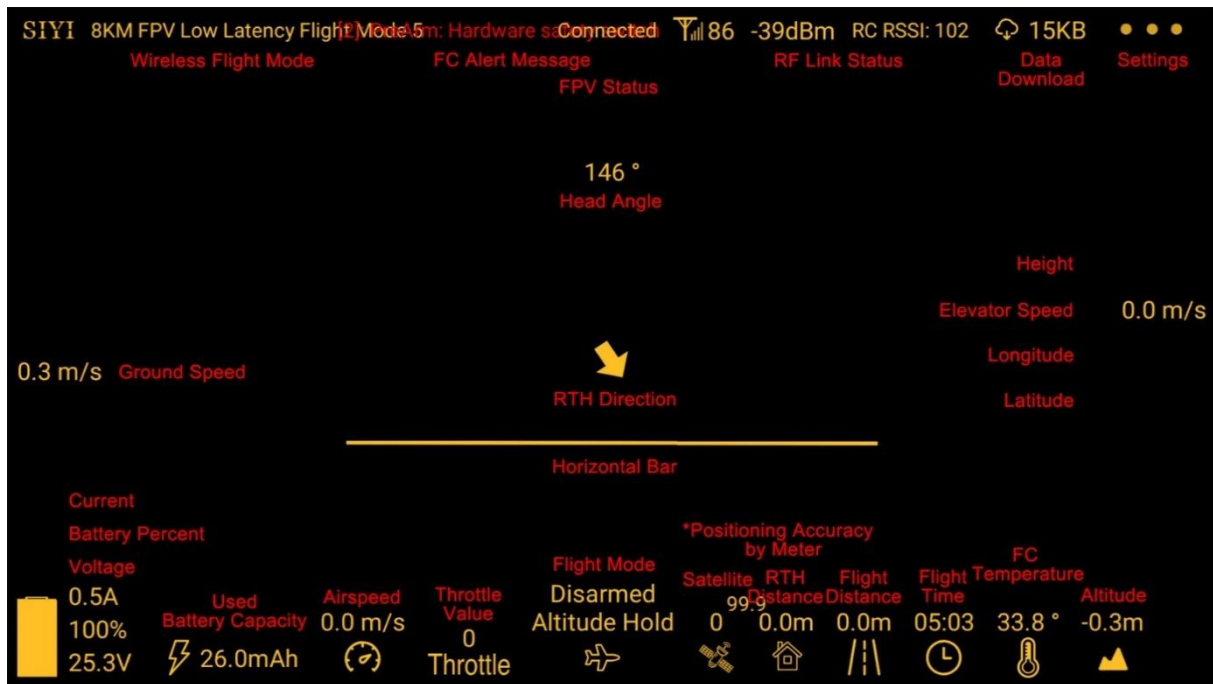

## SIYI FPV Camera Function Icon Definition



## 5.1 Settings

In the “Settings” page, you can configure camera IP Addresses, configure application interface, switch decoding type.

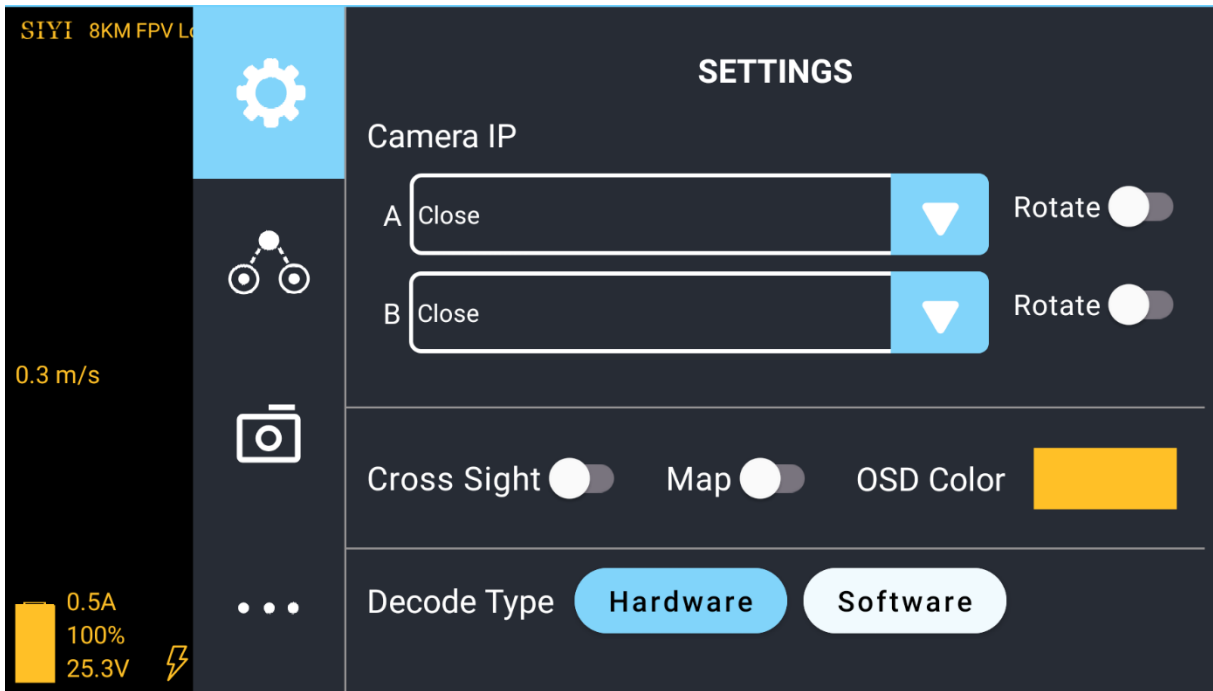

### About Settings

**Camera IP:** Select SIYI Camera 1 and SIYI Camera 2, or input camera RTSP addresses manually, or disable image. The “Rotate” buttons can rotate the image in 180 degrees.

**Cross Sight:** Display a cross sight in the center of the image.

**Map:** Display the flight map at the left-bottom corner of the app.

**OSD Color:** Adjust the color of all OSD information.

**Decoding Type:** Switch between “Hardware Decoding” and “Software Decoding”. Please refer to your video input device to choose the decoding type with the best performance.

## 5.2 Link Status

Display the link status directly over the FPV image.

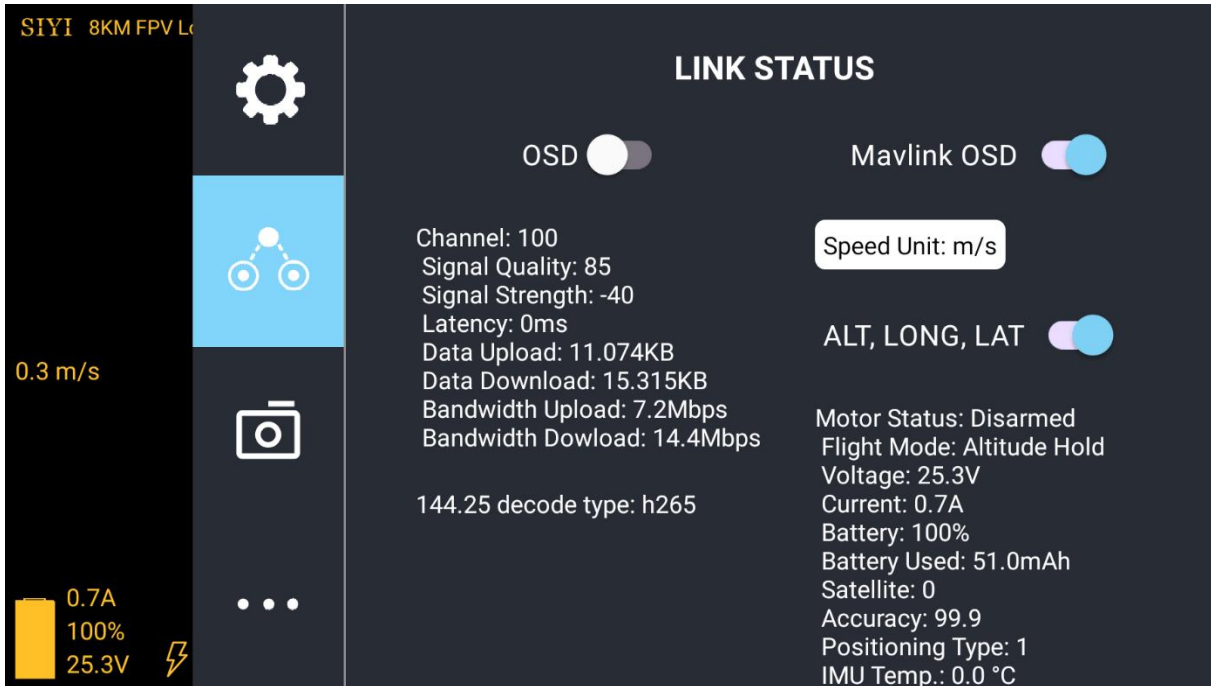

### About Link Status

OSD: Enable / disable standard OSD information.

Mavlink OSD: Enable / disable Mavlink OSD information.

Speed Unit: Switch speed unit between meter per seconds and kilometer per hour.

Longitude and Latitude: Enable / disable information.

## 5.3 Gimbal Camera

Configure the basic functions for SIYI gimbal cameras and cameras.

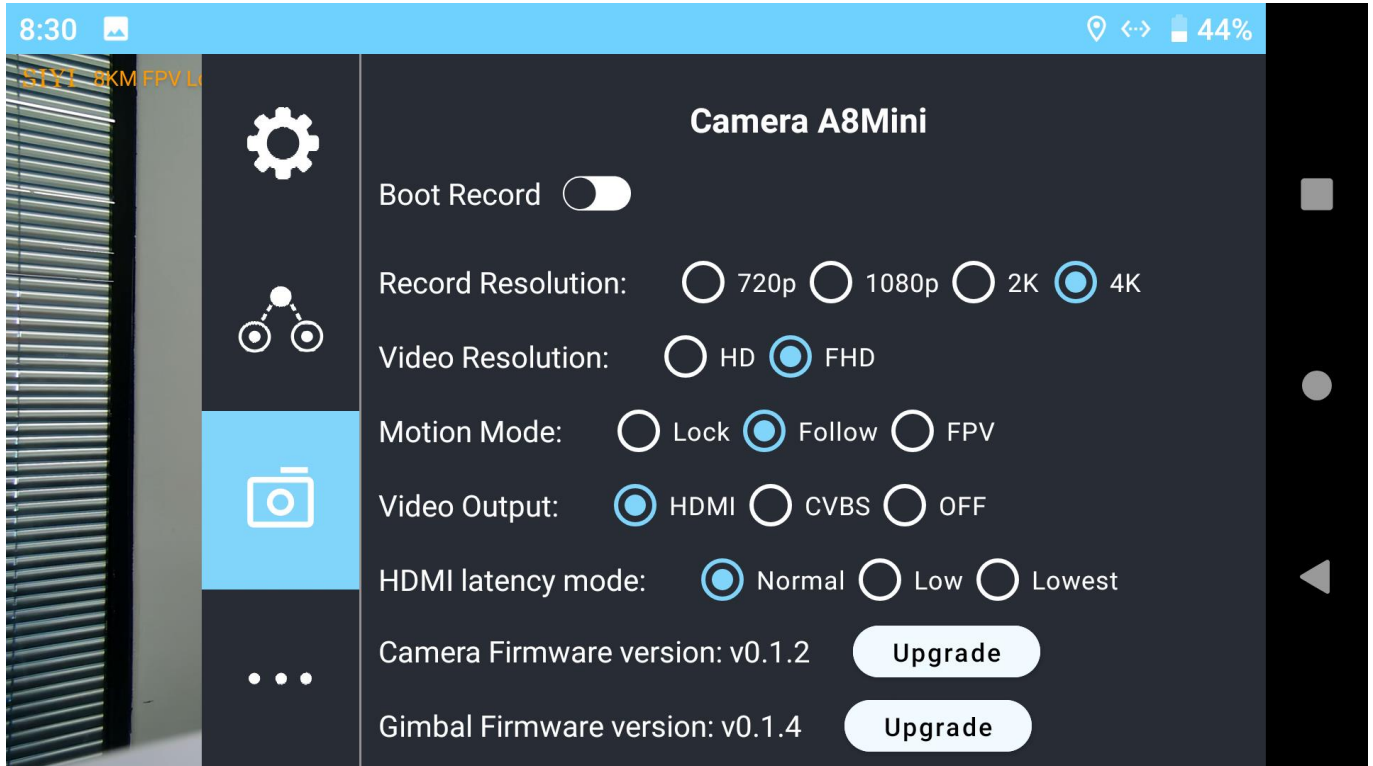

### About Gimbal Camera

**Auto Record:** Turn on / off automatically video recording by TF card on gimbal camera start.

**Record Resolution:** Switch camera record resolution between HD (720p), Full HD (1080p), 2K, and 4K (under 4K recording resolution, A8 mini camera does not zoom).

**Video Resolution:** Switch camera real-time streaming resolution between HD (720p) and Full HD (1080p).

**Working Mode:** Switch gimbal motion mode between Lock Mode, Follow Mode, and FPV Mode.

- Under Lock Mode, gimbal rotates simultaneously as aircraft rolls to get FPV and output

enhanced stable images, compatible with planes and racing drones especially for FPV scenes.

- Under Follow Mode, gimbal follows when aircraft rotates horizontally, compatible with multi-copter drones.
- Under Lock Mode, gimbal does not follow when aircraft rotates horizontally.

Video Output: Switch gimbal camera's video output method.

- HDMI: A8 mini gimbal camera outputs video stream through the Micro-HDMI port.
- CVBS: A8 mini gimbal camera outputs video stream through the CVBS pin of the Ethernet port by AV signal.
- OFF: A8 mini gimbal camera only outputs video stream through the Ethernet port.

HDMI Latency Mode: Switch A8 mini gimbal camera's latency mode under HDMI / CVBS video output method.

- Normal: Ethernet port outputs video stream, recording function is normal.
- Low Latency: Ethernet port video output is disabled, recording function is normal.
- Lowest Latency: Both Ethernet port video output and recording function are disabled.

Camera Firmware Version: Display the current camera firmware version.

Gimbal Firmware Version: Display the current gimbal firmware version.

## **Mark**

After switching video output mode or HDMI latency mode, gimbal camera should be restarted to implement the change.

Gimbal working mode is Follow Mode in default every time it is started.

## 5.4 About SIYI FPV

Displays the software version of SIYI FPV and common contact information of SIYI Technology.

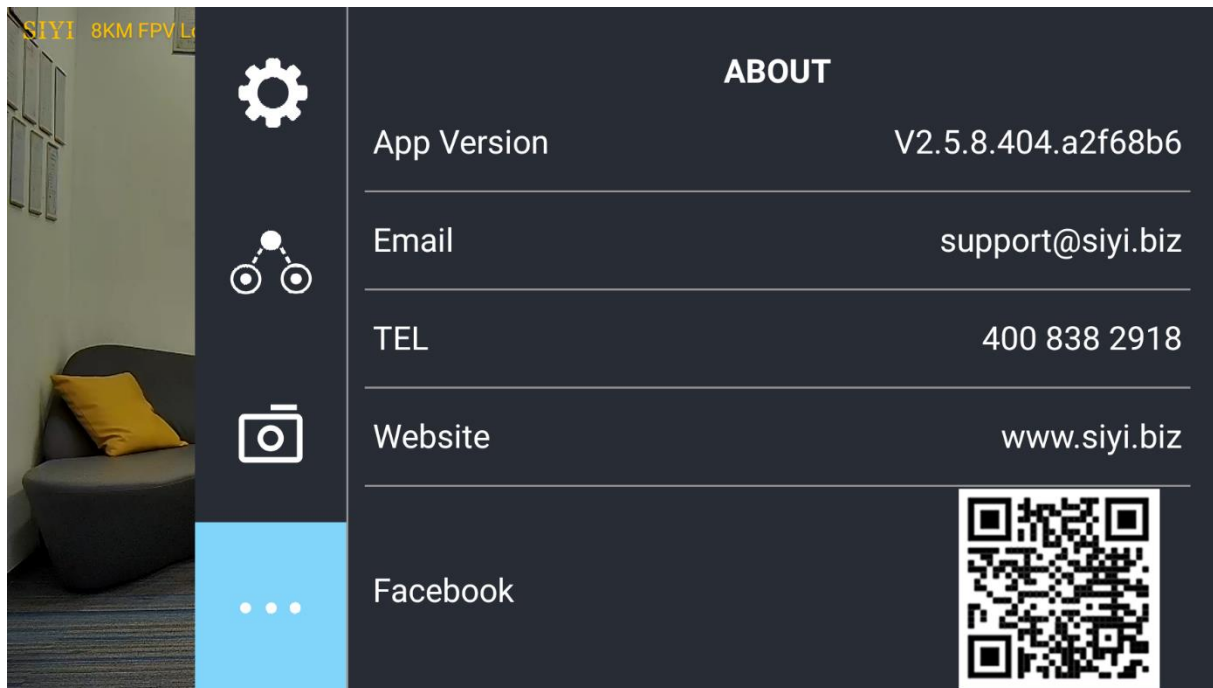

## 6 Firmware Upgrade and Configuration

SIYI PC Assistant is a Windows software developed by SIYI to configure almost all SIYI devices for remote controller channels settings, firmware update, and gimbal camera configuration.

### **Mark**

The manual is edited based on SIYI PC Assistant v1.3.2.

### 6.1 Gimbal / Zoom Firmware Update

SIYI gimbal camera can be connected to SIYI PC Assistant for gimbal firmware and zoom firmware update.

Before upgrading, it is necessary to prepare the tools, software, and firmware below.

- SIYI PC Assistant (v1.3.2 or latest version)
- Gimbal Firmware

### **Mark**

Above software and firmware can be downloaded from relevant product page in SIYI Official Store (<https://shop.siyi.biz>) or from A8 mini Google Drive Link ([https://drive.google.com/drive/folders/1aSuleJW6OYt8UTtW0osgL20lkXcMuGxp?usp=share\\_link](https://drive.google.com/drive/folders/1aSuleJW6OYt8UTtW0osgL20lkXcMuGxp?usp=share_link)) or got from your dealer.

- Cable (USB-C to USB-A)

### **Mark**

Customers should prepare the above tools.

## **Firmware Upgrade Steps**

1. Install “SIYI PC Assistant” on your Windows device.
2. Use the USB-C to USB-A cable to connect Windows device’s USB-A port to gimbal camera’s USB-C port.
3. Run “SIYI PC Assistant” and switch to “Upgrade” page to check gimbal camera’s current gimbal firmware version.



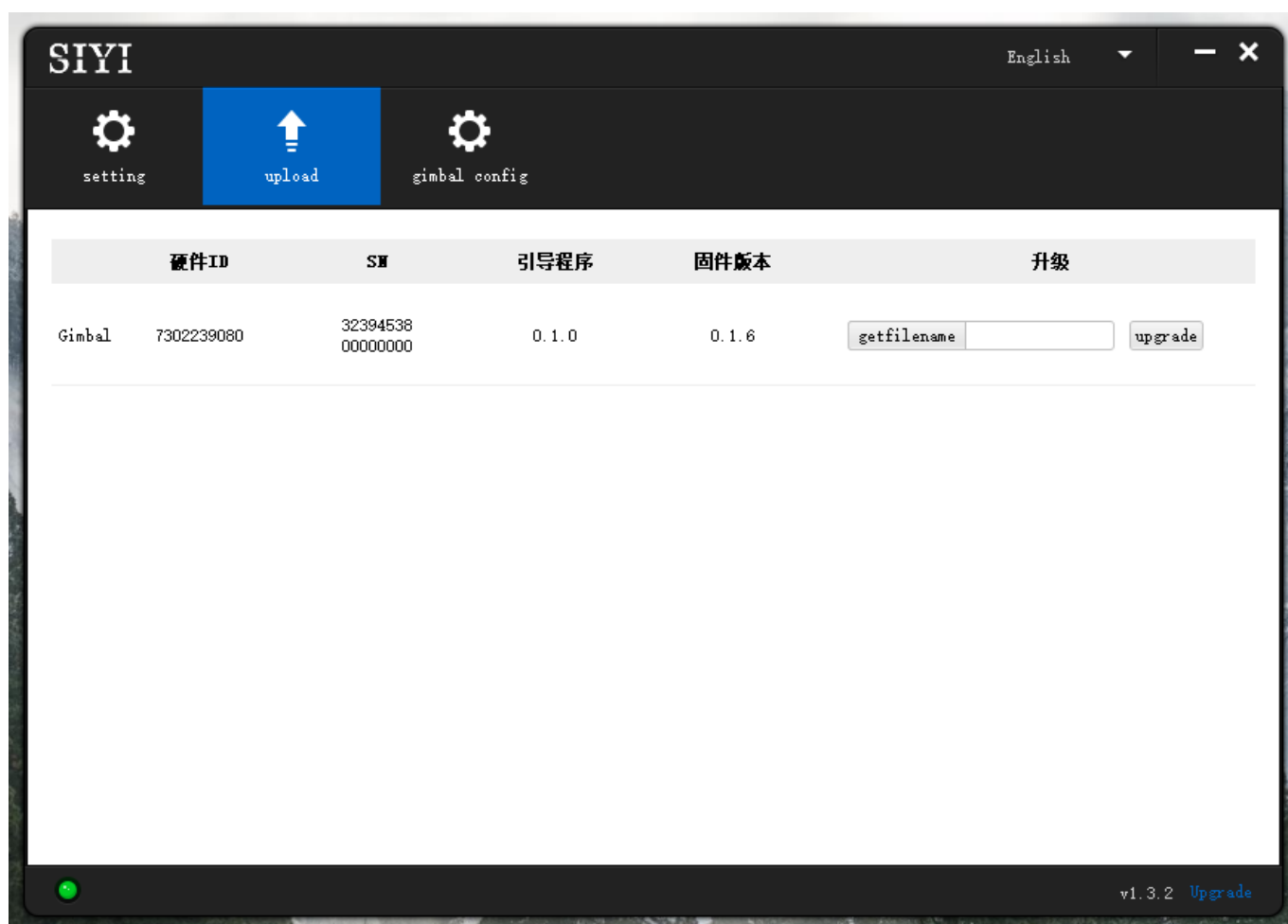

4. If gimbal firmware is not latest, then click the “Select File” button in the “Gimbal” to import the latest firmware. And click “Upgrade” and wait till it is “100%” finished.

**Mark**

Before updating any firmware, gimbal camera should be powered.

## 6.2 Camera Firmware Update

SIYI gimbal camera can be upgraded by SD / TF card for camera firmware.

Before upgrading, it is necessary to prepare below tools, software, and firmware below.

- SD / TF card

### Mark

Customers should prepare the above tools.

- Camera Firmware

### Mark

Above software and firmware can be downloaded from relevant product page on SIYI Official Store (<https://shop.siyi.biz>) or from A8 mini Google Drive Link ([https://drive.google.com/drive/folders/1aSuleJW6OYt8UTtW0osgL20lkXcMuGxp?usp=share\\_link](https://drive.google.com/drive/folders/1aSuleJW6OYt8UTtW0osgL20lkXcMuGxp?usp=share_link)) or got from your dealer.

## Firmware Upgrade Steps

1. Save camera firmware's ".bin" file to the SD / TF card's root directory and do not change the file name.

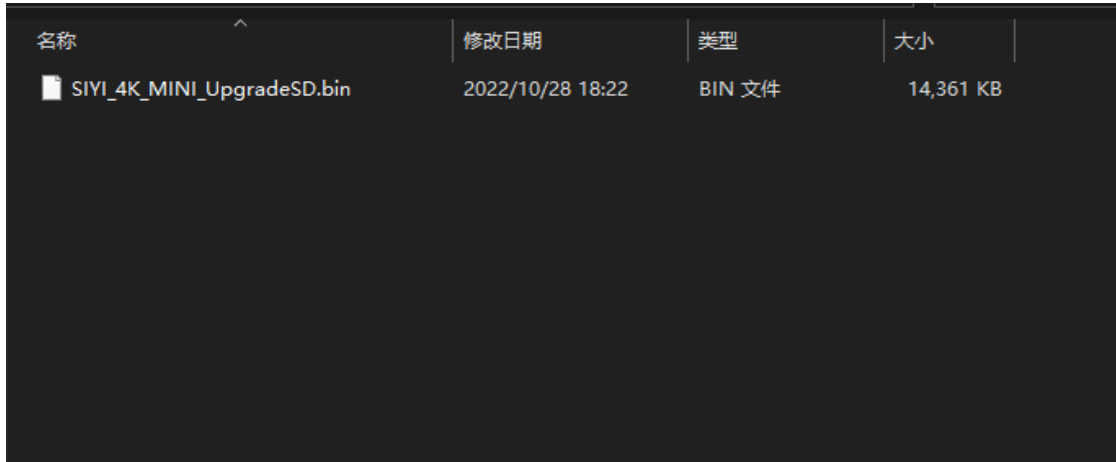

2. Restart gimbal camera and wait for 3 to 5 minutes. Camera firmware will be flashed automatically.
3. Run SIYI FPV app or SIYI PC Assistant software to check if camera firmware is updated successfully.

## 6.3 Gimbal Camera Configuration

SIYI gimbal camera can be connected to SIYI PC Assistant for channel settings and camera settings.

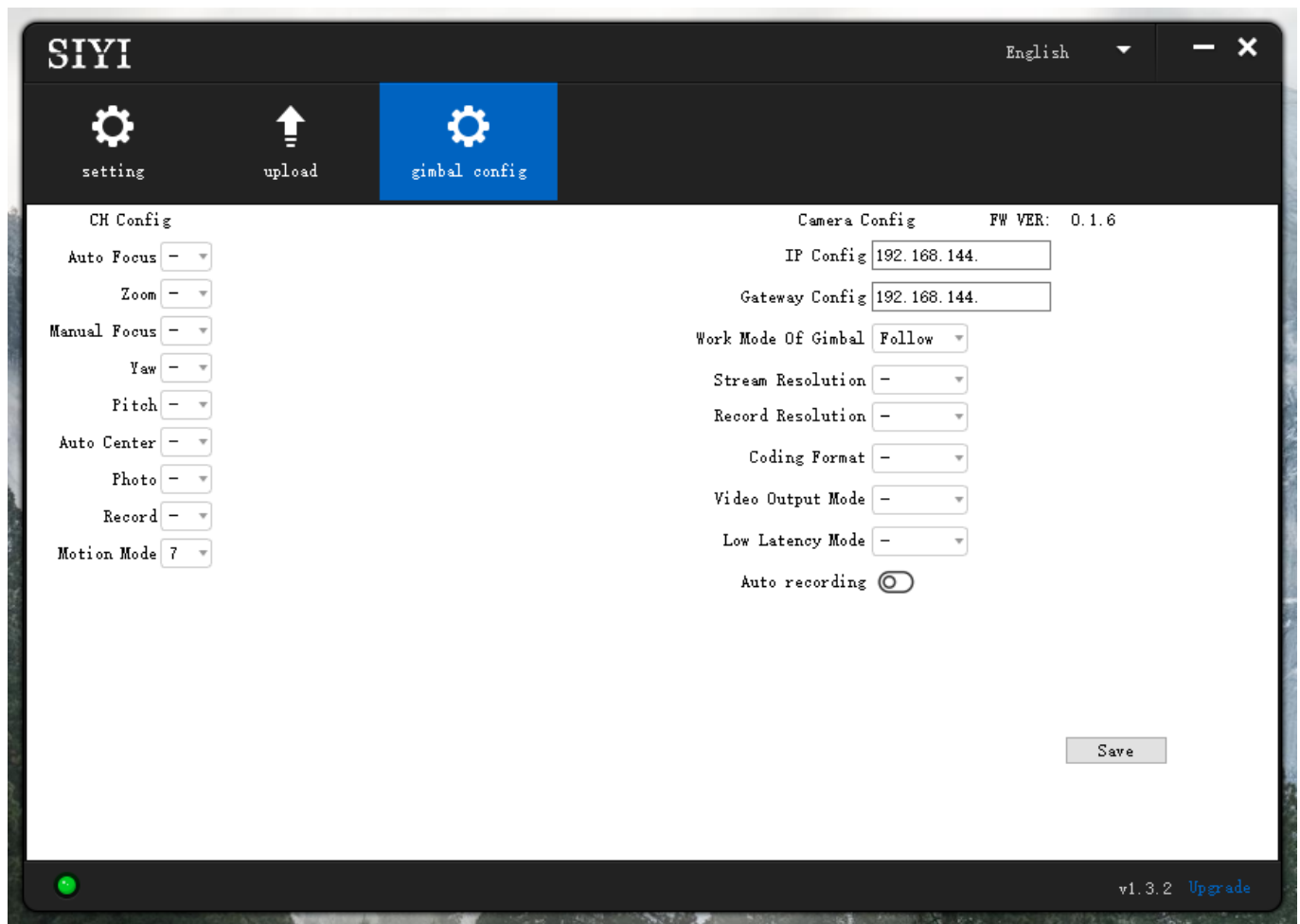

### 6.3.1 Channel Settings

The “Channel Config” menu under “Gimbal Config” menu can config the below gimbal camera functions to up to 16 channels and an idle channel (disabled).

- Auto Focus
- Zoom
- Manual Focus

- Yaw
- Pitch
- Auto Center
- Photo
- Record
- Motion Mode

### 6.3.2 Camera Specs

The “Gimbal Config” menu also supports checking gimbal camera’s current camera firmware, switching camera resolution, and configuring camera IP addresses.

- IP Config
- Gateway Config
- Gimbal Working Mode
- Stream Resolution
- Record Resolution
- Coding Format

- Video Output Mode
- Low Latency Mode
- Auto Recording

## 7 After-sale Service

If there were any questions or problems using SIYI Technology's product, you can always try to send an email to SIYI Official A/S Center ([support@siyi.biz](mailto:support@siyi.biz)) or consult your sales representative or dealer for answers or solutions.

### 7.1 Repair Service

If your purchased SIYI products cannot work properly, please contact SIYI Official A/S Center for consulting.

Usually there are two situations for acquiring repair service.

- Product Defect
- Product Damage

SIYI products under the two situations can be sent back to SIYI for repairing. Defect products with valid warranty can be repaired for free. Defect products without valid warranty or damaged products should be charged of repair fees after repairing. Please refer to SIYI's Official A/S Quotation for detail.

## 7.2 Warranty

SIYI Technology guarantees that, subject to the following conditions, Return & Refund Service, Replacement Service, and Warranty Repair Service can be requested. Please contact SIYI directly ([support@siyi.biz](mailto:support@siyi.biz) or your sales manager) or authorized SIYI dealer for more detail.

### 7.2.1 7-Day Return & Refund

You can request Return & Refund Service:

Within seven (7) days of receiving a product if the product has no manufacturing defect, has not been activated and is still in new or like-new condition.

Within seven (7) days of receiving a product if the product has a manufacturing defect.

Return & Refund Service will not be provided where:

It is requested beyond seven (7) calendar days of receiving a product.

A product sent to SIYI for Return & Refund Service does not include all original accessories, attachments or packaging, or any item is not in new or like-new condition, i.e., with cracks, dents, or scratches.

A legal proof of purchase, receipt or invoice is not provided or is reasonably believed to have been forged or tampered with.



Any fault or damage of the product is caused by unauthorized use or modification of the product, including exposure to moisture, entry of foreign bodies (water, oil, sand, etc.) or improper installation or operation.

Product labels, serial numbers, waterproof marks, etc. show signs of tampering or alteration.

Damage is caused to the product by uncontrollable external factors, including fire, floods, high winds, or lightning strikes.

A product is not delivered to SIYI within seven (7) calendar days after Return & Refund Service confirmation is sent from SIYI.

Other circumstances stated in this policy.

## **7.2.2 15-Day Replacement**

You can request Replacement Service:

Within fifteen (15) calendar days of receiving the product if the product has sustained a substantial damage in transit, provided always that the damage proof issued by the carrier can be provided to SIYI.

Within fifteen (15) calendar days of receiving the product if the product does not match the original description of the product in one or more significant respects.

Within fifteen (15) calendar days of receiving the product if the product suffers performance failure.

Replacement Service will not be provided where:

Service is requested more than fifteen (15) calendars days after receiving a product.

Legal proof-of-purchase, receipts, or invoices are not provided, or are reasonably believed to have been forged or tampered with.

A product sent to SIYI for replacement does not include all original accessories, attachments, and packaging, or contains items damaged by user error.

A product is found to have no defects after all appropriate tests are conducted by SIYI.

Any fault or damage of the product is caused by unauthorized use or modification of the product, including exposure to moisture, entry of foreign bodies (water, oil, sand, etc.) or improper installation or operation.

Damage is caused by uncontrollable external factors, including fires, floods, high winds, or lightning strikes.

Received product has not been sent back to SIYI seven (7) calendar days after replacement confirmation from SIYI.

Proof of damage during transit issued by the carrier cannot be provided.

Other circumstances stated in this policy.

### 7.2.3 1-Year Warranty Repair

You can request warranty repair service:

If a product does not function as warranted during the warranty period, you may obtain after-sales service by contacting SIYI's service center. You will need to provide a valid proof-of-purchase, receipt, or order number for the warranty service.

Charges may apply for services not covered by this Limited Warranty. Please contact SIYI for information specific to your location.

Please note that the warranty service is only available in the respective SIYI service regions where you purchased your SIYI product.

Warranty Repair service will not be provided where:

Crashes or fire damage caused by non-manufacturing factors, including but not limited to pilot errors.

Damage caused by unauthorized modification, disassembly, or shell opening not in accordance with official instructions or manuals.

Damage caused by improper installation, in correct use, or operation not in accordance with official instructions or manuals.

Damage caused by non-authorized service provider.

Damage caused by unauthorized modification of circuits and mismatch or misuse of the battery and charger.

Damage caused by operation in bad weather (i.e., strong winds, rain, sand/dust storms, etc.)

Damage caused by operating the product in an environment with electromagnetic interference (i.e., in mining areas or close to radio transmission towers, high-voltage wires, substations, etc.)

Damage caused by operating the product in an environment suffering from interference from other wireless devices (i.e., transmitter, video-downlink, Wi-Fi signals, etc.)

Damage caused by reliability or compatibility issues when using unauthorized third-party parts.

Damage caused by operating the unit with a low-charged or defective battery.

Products or parts with an altered identification label or from which the identification label has been removed.

**SIYI Technology (Shenzhen) Co., Ltd**

Business Inquiry: [info@siyi.biz](mailto:info@siyi.biz)

Phone: +86 400 838 2918

A/S Center: [support@siyi.biz](mailto:support@siyi.biz)