



AirVelocity 1500 Installation Guide

Part Number: DUG01560

System Release: 16.5

Revision: A

Published: March 2019

© Copyright by **Airspan Networks Ltd.**, 2018-2019. All rights reserved worldwide.

Legal Notices

The information contained within this document is proprietary, privileged and intended only for the recipient. As such, the information is subject to all relevant copyright, patent and other laws protecting intellectual property, as well as any specific agreements protecting Airspan Networks Ltd. rights in the aforesaid information. Neither this document nor the information contained herein may be published, reproduced, transmitted or disclosed to third parties, in whole or in part, without the express, prior, written permission of Airspan Networks Ltd. In addition, any use of this document or the information contained herein for the purposes other than those for which it is disclosed is strictly forbidden.

Airspan Networks Ltd. reserves the right, without prior notice or liability, to make changes in equipment design or specifications.

Information supplied by Airspan Networks Ltd. is believed in good faith to be accurate and reliable, while every care has been taken in preparing these documents. However, Airspan Networks Ltd. does not make any representations and gives no warranties of whatever nature in respect of these documents, including without limitation, the accuracy or completeness of any information, facts and/or opinions contained therein. No responsibility is assumed by Airspan Networks Ltd. for the use of the documents nor for the rights of third parties which may be effected in any way by the use thereof. The provision of these documents (and the documents themselves) does not constitute professional advice of any kind. Any representation(s) in these documents concerning performance of Airspan Networks Ltd. product(s) are for informational purposes only and are not warranties of future performance, either expressed or implied. Airspan Networks Ltd., its affiliates, directors, employees and agents shall not be held liable for any damages or losses, of any nature whatsoever, arising from any use of and/or reliance on the documents.

These documents may contain flaws, omissions or typesetting errors; no warranty is granted nor liability assumed in relation thereto unless specifically undertaken in Airspan Networks Ltd. sales contract or order confirmation. Information contained herein is periodically updated and changes will be incorporated into subsequent editions. If you have encountered an error, please notify Airspan Networks Ltd.

Product performance figures quoted within this document are indicative and for information purposes only.

UK WEEE Registration number: WEEE/AB0207WZ. For more information, see [WEEE Information for Airspan Customers and Recyclers](#).

Acknowledgements



© Intel Corporation <http://www.intel.com/>



© Microsoft Corporation <http://www.microsoft.com>

Table of Contents

Document Information	4
Abstract.....	4
Revision History	4
Warnings and Cautions	2
Human Exposure to Radio Frequencies	2
Radio Interference.....	2
Modifications	2
General	2
⚠ Important Safety Instructions	2
Safety.....	2
Warning of Hazardous Voltages	3
Adherence to European Directive 2014/53/EU	4
Warning Symbols.....	4
Service Information	4
UL Information	4
DECLARATION OF CONFORMITY	5
Maximum Output TX Total Power	7
Product Variants	7
Power Consumption.....	7
LTE Antenna System	8
Integral Sectorial Antenna.....	8
About This Document.....	9
Purpose.....	9
Intended Audience	9
Document Conventions.....	9
Related Reading	9
Customer Care Help Desk	10
Airspan Encourages Comments	10
1 Introduction	11

1.1 AirVelocity 1500	11
2 Getting Started.....	12
2.1 AirVelocity 1500 Installation Checklist.....	12
3 Verifying Prerequisites.....	13
3.1 Verifying Site Requirements	13
3.2 Verify Installation Requirements.....	13
3.2.1 Verify the Tools	13
3.2.2 Verify the Parts and Kits.....	13
3.2.3 Power Supply	14
3.2.4 Verify Components.....	14
3.2.5 Physical Dimensions	15
3.2.6 Environmental	16
4 AirVelocity 1500 Installation	17
4.1 Ceiling Mount	17
4.1.1 Suspended Ceiling Assembly.....	17
4.1.2 Conventional Ceiling Assembly	21
4.2 Wall Mount Assembly	23
4.3 LED Display	25
5 Connect and Manage Cables	26
5.1 DC Cable Connection.....	26
5.2 Mounting the AC to POE++/DC Power Supply.....	26
5.3 Ethernet Cable Installation	26
5.3.1 Copper Ethernet Cable.....	26
5.3.2 Fiber Ethernet (SFP) Cable	26
6 GPS Antenna Mounting.....	27
6.1 Verify the Parts and Kits.....	27
A Job Sheet.....	29
B Checklist	30
C Abbreviations	31

Figures

Figure 1: AirVelocity 1500.....	11
Figure 2: AirVelocity 1500 Ports (DC Variant)	15
Figure 3: Assemble Rail Brackets to the Unit	17
Figure 4: Assemble Rail Plates to the Mounting Plate	18
Figure 5: Ceiling Mounting Plate & Rails onto Ceiling Rails	18
Figure 6: Slide and Clinch the Rail Plates onto the Ceiling Rails.....	18
Figure 7: Engage the Rail Brackets Projections into the Ceiling Plate Slots	19
Figure 8: Swing Unit into Place and Insert the Locking Pin	19
Figure 9: Insert and Click Close the Safety Cable	19
Figure 10: Assemble Rail Brackets to the Unit	21
Figure 11: Attach Mounting Bracket to Standard Ceiling.....	21
Figure 12: Mounting AirVelocity 1500 on Conventional Ceiling	22
Figure 13: Insert & Secure Locking Pin	22
Figure 14: Assemble Rail Brackets to the Unit	23
Figure 15: Insert Anchors & Screws in Wall.....	23
Figure 16: Insert Anchors & Screws in Wall.....	24
Figure 17: Push Down to Engage Screw Heads.....	24
Figure 18: DC Power Plug	26
Figure 19: DC In - Panel	26
Figure 20: GPS Antenna.....	27

Tables

Table 1: AirVelocity 1500 ETSI / FCC Maximum Output TX Total Power	7
Table 2: Supported Frequency Bands.....	7
Table 3: Power Consumption.....	7
Table 4: Integral Sector Antenna Parameters (LTE)	8
Table 5: Typographic Conventions.....	9
Table 6. Minimum Hardware Requirements	13
Table 7. Parts & Kits.....	13
Table 8 AirVelocity 1500 Power Supply Options.....	14
Table 9 AirVelocity 1500 Components	14
Table 10. AirVelocity 1500 Physical Dimensions	15
Table 11: AirVelocity 1500 Components Weight.....	15
Table 12. AirVelocity 1500 Environment Compliance	16

Table 13: LED Display	25
Table 14: GPS Kit Contents	27
Table 15: ABBREVIATIONS & DEFINITIONS	31

Document Information

Abstract

This document details procedures for installing the Airspan's AirVelocity 1500 Indoor-Pico Enterprise eNodeB variant.

Revision History

Revision Details	Date	Summary of Changes
Rev 0.1	January 2019	<ul style="list-style-type: none"> Initial document – draft comments
Rev 0.2 – 0.4	March 2019	<ul style="list-style-type: none"> comments new mounting variations
Rev A	March 2019	<ul style="list-style-type: none"> comments Update EU Directive Publish
Rev A1	March 2019	<ul style="list-style-type: none"> Added bracket assembly on the unit

Warnings and Cautions

Human Exposure to Radio Frequencies

The AirVelocity 1500 should be installed and operated from a minimum safe distance of about 48Cm (18.9 in).

Radio Interference

This AirVelocity 1500 generates, uses, and can radiate radio frequency energy and, if not installed and used in accordance with the instructions, may cause harmful interference to radio communications. However, there is no guarantee that interference will not occur in a particular installation. If this equipment does cause harmful interference to radio, television reception, which can be determined by turning the equipment on and off, the technician is encouraged to try to correct the interference by performing one or more of the following measures:

- Re-orientate or relocate the unit
- Increase separation between the units and/or End Devices
- Connect the equipment to an outlet on a circuit different from that to which the power source is connected

Modifications

Any changes and modifications to this device that are not expressly approved by Airspan Networks may void the user's authority to operate the equipment.

General

- Only qualified personnel should be allowed to install, replace, and service the equipment.
- The device cannot be sold retail, to the general public or by mail order. It must be sold to operators.
- Installation must be controlled.
- Installation must be performed by licensed professionals.
- Installation requires special training. The AirVelocity 1500 should be installed ONLY by experienced installation professionals who are familiar with local building and safety codes and, wherever applicable, are licensed by the appropriate government regulatory authorities. Failure to do so may void Airspan's product warranty and may expose the end user or the service provider to legal and financial liabilities. Airspan and its resellers or distributors are not liable for injury, damage or violation of regulations associated with the installation of outdoor units or antennas.

Important Safety Instructions

- Read and Save these instructions
- This Installation Guide contains instructions and warnings that should be followed during installation, and operation.
- Failure to follow these instructions could cause bodily injury and/or product failure

Safety

1. Read this guide and follow all operating and safety instructions.
2. Keep all product information for future reference.
3. No user serviceable parts inside.
4. Position the power cord to avoid possible damage; do not overload circuits.
5. Do not place this product on or near a direct heat source, and avoid placing objects on the terminal.
6. Use only a damp cloth for cleaning. Do not use liquid or aerosol cleaners. Disconnect the power before cleaning.

7. The units should not be located near power lines or other electrical power circuits.
8. It is the installer's responsibility to install this device in accordance with the local electrical codes.
9. Installation of the AirVelocity 1500 must be contracted to a professional installer.
10. Disconnect Device. The socket outlet should be easily accessible in case you have to disconnect the device.
11. When installed in the final configuration, the product must comply with the applicable Safety Standards and regulatory requirements of the country in which it is installed. If necessary, consult with the appropriate regulatory agencies and inspection authorities to ensure compliance.

Warning of Hazardous Voltages

On AC installations, hazardous voltages exist. Use caution when verifying or working with AC power. Remove metal jewellery that could come into contact with AC power.

On DC sections, short-circuiting the low voltage, low impedance circuits can cause severe arcing that may result in burns or eye damage. Remove rings, watches etc. to avoid shorting DC circuits.

Note: Airspan products do not contain hazardous substances (as defined in UK Control of Substances Hazardous to Health Regulations 1989 and the Dangerous Substances Regulations 1990). At the end of any Airspan products life cycle, the customer should consult with Airspan to ensure that the product is disposed of in conformance with the relevant regulatory requirements.

Adherence to European Directive 2014/53/EU

European Council Recommendation 2014/53/EU details basic restrictions and reference levels on human exposure to electromagnetic fields as advised by the ICNIRP. Adherence to these recommended restrictions and reference levels should provide a high level of protection as regards the established health effects that may result from exposure to electromagnetic fields.

Warning Symbols

The following symbols may be encountered during installation or troubleshooting. These warning symbols mean danger. Bodily injury may result if you are not aware of the safety hazards involved in working with electrical equipment and radio transmitters. Familiarize yourself with standard safety practices before continuing.



Caution, hot surface



Caution



Electro-Magnetic
Radiation



DC

Service Information

Refer all repairs to qualified service personnel. Do not modify any part of this device, as this will void the warranty.

Disconnect the power to this product and return it for service if the following conditions apply:

- a. The terminal does not function after following the operating instructions outlined in this manual.
- b. Liquid has been spilled, a foreign object is inside, or the terminal has been exposed to rain.
- c. The product has been dropped or the housing is damaged.

Locate the serial number of the terminal and record this on your registration card for future reference. Also record the MAC address, located on the product sticker.

UL Information

- The electrical source must be properly grounded according with NEC and other local safety code requirements.
- AirVelocity 1500 is designed to operate in environmental conditions complying with IP40 and relevant standards.

DECLARATION OF CONFORMITY

Declaration of Conformity with Regard to the R&TTE Directive 2014/53/EU

Czech:

Airspan tímto prohlašuje, že tento přístroj je ve shodě se základními požadavky a dalšími příslušnými ustanoveními směrnice 2014/53 / EU.

Danish:

Undertegnede, Airspan erklærer hermed, at følgende udstyrsenhed opfylder de væsentlige krav og andre relevante krav i direktiv 2014/53 / EF.

Deutsch:

Hiermit erklärt Airspan, dass die Produkteinheit die grundlegenden Anforderungen und anderen relevanten Bestimmungen der Richtlinie 2014/53 / EU erfüllt.

Estonian:

Käesolevaga kinnitab Airspan, et seadme seade vastab direktiivi 2014/53 / EL oluliste nõuetele ja muudele kõnealuse direktiivi asjakohastele sätetele.

English:

This equipment is in compliance with the essential requirements and other relevant provisions of Directive 2014/53/EU.

Español:

Por medio de este Airspan, declara que la unidad cumple con los requisitos esenciales y cualquier otra disposición aplicable o exigible de la Directiva 2014/53 / UE.

Greek:

ΜΕ ΤΗΝ ΠΑΡΟΥΣΑ ΠΡΟΔΙΑΓΡΑΦΗ, η Airspan ΔΗΛΩΝΕΤΑΙ ότι η μονάδα συμμορφώνεται με τις ουσιώδεις απαιτήσεις και τις λοιπές σχετικές διατάξεις της οδηγίας 2014/53 / ΕΕ.

Français:

Airspan déclare par la présente que l'appareil est conforme aux exigences essentielles et aux autres dispositions pertinentes de la directive 2014/53 / UE.

Italiano:

Con la presente Airspan dichiara che questa unità è conforme ai requisiti essenziali e alle altre disposizioni pertinenti stabilite dalla direttiva 2014/53 / UE.

Latvian:

Ar šo Airspan paziņo, ka vienība atbilst Direktīvas 2014/53 / ES būtiskajām prasībām un citiem attiecīgajiem noteikumiem;

Lithuanian:

Šis „Airspan“ pareiškia, kad šis įrenginys atitinka esminius Direktyvos 2014/53 / ES reikalavimus ir kitas nuostatas.

Nederlands:

Airspan verklaart hierbij dat de apparaateenheid voldoet aan de essentiële vereisten en andere relevante bepalingen van richtlijn 2014/53 / EU.

Maltese:

Hawnhekk, Airspan, tiddikjara li din l-unità tikkonforma mar-reqwiżiti essenzjali u dispożizzjonijiet rilevanti oħra li jinsabu fid-Direttiva 2014/53 / UE.

Hungarian:

Alulírott, az Airspan kijelenti, hogy az egység megfelel a 2014/53 / EU irányelv vonatkozó alapvető követelményeinek és egyéb követelményeinek.

Polish:

Niniejszym Airspan oświadcza, że urządzenie jest zgodne z zasadniczymi wymaganiami i innymi odpowiednimi postanowieniami dyrektywy 2014/53 / UE.

Português:

Airspan declara que esta unidade está em conformidade com os requisitos essenciais e outras disposições da Diretiva 2014/53 / UE.

Slovenian:

Airspan izjavlja, da je ta enota skladna z bistvenimi zahtevami in drugimi ustreznimi določbami Direktive 2014/53 / EU.

Slovak:

Airspan týmto vyhlasuje, že tento prístroj spĺňa základné požiadavky a všetky príslušné ustanovenia Smernice 2014/53 / EU.

Suomalainen:

Airspan vakuuttaa täten, että laitteen tyyppi on direktiivin 2014/53 / EU olennaisten vaatimusten ja muiden asiaankuuluvien säännösten mukainen.

Swedish:

Därmed intygar Airspan att denna enhet överensstämmer med de väsentliga egenskapskraven och andra relevanta bestämmelser som anges i direktiv 2014/53 / EU.

Íslenska:

Airspan lýsir hér með yfir að þessi eining uppfylli grunnkröfur og aðrar kröfur tilskipunar 2014/53 / ESB.

Norsk:

Airspan erklærer herved at utstyrsenheden oppfyller grunnleggende krav og andre relevante krav i direktiv 2014/53 / EU.

Român:

Airspan declarâm pe propria răspundere că produsul produsului respectă cerințele esențiale și alte prevederi aplicabile din Directiva 2014/53 / UE.

The Declaration of Conformity related to this product can be obtained from PLM@Airspan.com.

Maximum Output TX Total Power

Table 1: AirVelocity 1500 ETSI / FCC Maximum Output TX Total Power

Frequency Band (MHz)	ETSI TX (dBm)	ETSI EIRP (dBm)	Antenna Gain (dBi)	Variant
3550 - 3700	4x 25 (4x 316mW)	33 (2W)	8	1500

Caution: Do not set maximum output TX total power to higher than local regulations.

Product Variants

AirVelocity supports the following frequency bands with the specific performance values:

Table 2: Supported Frequency Bands

Band	Product Code	Downlink Freq. (MHz)	Uplink Freq. (MHz)	Duplex	Tx Power per Channel (dBm, mW)
48 (42H, 43L)	VNG15-U48-B08P3D	3550 - 3700	3550 - 3700	TDD	4x 25dBm, (4x 316mW)

Power Consumption

AirVelocity 1500 has a maximum nominal power consumption of 30W. AirVelocity 1500 power consumption is described in the following table:

Table 3: Power Consumption

Duplex	LTE Tx Power Before the Antenna (dBm)	Nominal Power Consumption (W)
TDD	25	≤30

Note:

- Nominal Power Consumption (W) - refers to average power consumption over time.
- Power Supply Requirement (W) - refers to the required power supply rating connected to the eNodeB

LTE Antenna System

The following antenna is designed specifically for AirVelocity 1500 deployments; specifications are described in this section.

Integral Sectorial Antenna

The integral sectorial antenna is a cross-polarized fixed antenna which is an inseparable part of the unit. Use of an external antenna is not part of the product design.

LTE Antennas

AirVelocity 1500 has a sectorial antenna that behaves as an Omni antenna for ceiling mount and Directional antenna for wall mounting.

Note: The integral LTE antenna included is dependent on the product's LTE band.

Table 4: Integral Sector Antenna Parameters (LTE)

Frequency [GHz]	Boresight gain (typical)	Mounting location	Horizontal 3dB BW (typical)	Vertical 3dB BW (typical)
3.55 – 3.7	8 dBi	Wall	65°	65°
		Ceiling	Omni	30°

About This Document

Purpose

This guide provides the workflow and step-by-step procedures for installing the Airspan's AirVelocity 1500, Enterprise-Pico eNodeB variant. These procedures include:

- Verify prerequisites
- Install Mounting bracket (Ceiling or Wall)
- Install the AirVelocity 1500
- Install GPS Antenna (if required)
- Connect and manage cables

Intended Audience

This guide is intended for persons who are responsible for installing the AirVelocity 1500 equipment. These persons should have a working knowledge of LTE.

Document Conventions

This document uses the following typographic conventions.

Table 5: Typographic Conventions

Convention	Element
Blue underlined text	Cross-reference links.
Bold text	Keyboard buttons and GUI elements.
Command	Command names or phrases.
Computer output	Text displayed by the computer.
Hyperlinks	Website and e-mail addresses.
Danger	Signifies a hazardous situation—if not avoided—will cause death or serious injury. Describes how to avoid it.
Warning	Signifies a hazardous situation—if not avoided—can cause death or serious personal injury. Describes how to avoid it.
Caution	Signifies a hazardous situation—if not avoided—can void the product warranty, and cause property damage. Describes how to avoid it.
Important	Provides necessary information to explain a task.
Note	Provides additional information.
Tip	Provides helpful hints.

Related Reading

The following documents contain related information:

- AirVelocity 1500 Hardware Product Specification
- Airspan LTE Commissioning Manual

Customer Care Help Desk

Airspan's *Customer Care Help Desk* offers prompt and efficient customer support services.

Note: To avail Airspan's *Customer Care Help Desk* support, you must be a registered user and must have a valid support contract. To register, click [here](#) and fill the **Registration** form.

To create and update issue logs, send e-mails to [Customer Care Help Desk](#). Once you submit your issue, the system generates a new issue and sends an issue number for your reference. The system uses this issue number to categorize and store e-mails under the appropriate issue.

To help *Customer Care Help Desk* identify your issue, include the issue number and your *Customer Care Helpdesk* account details in all further communications.

Main Operations

Airspan Communications Ltd.
Capital Point
33 Bath Road
Slough, Berkshire
SL1 3UF, United Kingdom
Tel: +44-1895-467-100

Worldwide Headquarters

Airspan Networks Inc.
777, Yamato Road, Suite 105
Boca Raton, FL 3341-4408, USA
Tel: +1 561 893 8670

Airspan Encourages Comments

Airspan welcomes any feedback and suggestions that help to improve the quality of the documentation. Send your feedback to documentfeedback@airspan.com.

1 Introduction

This section provides a descriptive overview of the Airspan's AirVelocity 1500 Enterprise-Pico eNodeB and its place in the product suite.

1.1 AirVelocity 1500

AirVelocity 1500 is part of Airspan's carrier-class 4G Pico eNodeB family. AirVelocity 1500 supports 3GPP's Long Term Evolution (LTE) eNodeB, providing high-speed data and mobility, in order to meet the demands of the Broadband Wireless Access market.

AirVelocity 1500 is a super-compact, easy to install indoor pico-cell, allowing an operator to deploy LTE broadband services in Public Venues, as well as Enterprise Offices, supporting both wall and ceiling mounting.

AirVelocity 1500 is a high performance indoor pico eNB supporting a single sector non-contiguous dual carrier solution that can support up to a total of 40MHz bandwidth.

AirVelocity 1500 employs Software Defined Radio (SDR) technology, together with two transmit paths, two receive paths, antennas and clock synchronization – all in a highly integrated, physically small and light, targeted to blend seamlessly into the environment. This super compact pico product minimizes physical footprint, power consumption and operator OPEX.

AirVelocity 1500 LTE radio implements a quad 25 dBm (4 x 315mW) transmit channels, with an integral antenna.

Note: For management please refer to the Airspan LTE Commissioning Manual as well as the Netspan User Manual.

Figure 1: AirVelocity 1500



2 Getting Started

2.1 AirVelocity 1500 Installation Checklist

Plan the installation of the AirVelocity 1500 by using the Installation Checklist, which you can find as a removable job aid in [Appendix B](#) for this guide.

3 Verifying Prerequisites

Prior to installing the AirVelocity 1500, verify the required safety, power, tools, parts and components. This chapter includes the hardware, software, and client requirements for installation.

Important: Set up requirements for the installation is detailed in the **Job Sheet**, see [Appendix A](#).

3.1 Verifying Site Requirements

To set up the AirVelocity 1500, an IP connection to a Netspan server is required.

3.2 Verify Installation Requirements

3.2.1 Verify the Tools

Table 6. Minimum Hardware Requirements

Tool	Use
Phillips head screwdriver	Attach wall / ceiling mounting bracket
Spanner (wrench) M5	Tightening locking nuts when mounting

3.2.2 Verify the Parts and Kits

Note: Verify order and requirements to ensure the correct unit type is being installed.

Table 7. Parts & Kits

Installation Kit / Part	Part No.	Airspan No.	Consisting of:	Note:
AirVelocity 1500, 3.55 – 3.70 GHz	VNG15-U48-B08P3D	998-13-481, 998-13-481MS	AirVelocity 1500 BTS, 3.55GHz (B48), Ethernet copper backhaul, POE++ / DC input, including – P/N 402-00-813 - brackets – Qty.x2	Frequency band and assembly type-specific
AirVelocity 1500 Ceiling/Suspended Ceiling Mounting Kit	VNG15-SCMK-1	903-03-481	1x suspended ceiling/ceiling mounting plate 4x suspended ceiling rail plate(2) 1x Speed Link SLK with Y-Hook configuration with 2 mm Wire Rope Diameter Wire Rope Length=3.3' Necessary Hardware	One per unit Sold Separately
AirVelocity Mounting Kit	VNG15-CMK-1	903-03-482	1x suspended ceiling/ceiling mounting plate 1x Locking pin with key ring 6.5x15mm	One per unit Sold Separately

Note: Either suspended ceiling mounting kit or standard ceiling mounting kit is required, depending on field conditions. Suspended ceiling mounting kit includes the standard ceiling mounting option.

3.2.3 Power Supply

AirVelocity 1500 supports direct connection to DC power source or to POE++ power source:

- **RJ45 POE++ Operational Voltage Range:** 50.0–57.0 Vdc, IEEE802.3bt class 6
- **DC port Operational Voltage Range:** 9-14Vdc

AC to POE++ injector or AC to DC power supply are not included with the AirVelocity 1500 and can be ordered separately.

Table 8 AirVelocity 1500 Power Supply Options







Installation Kit / Part	Part No.	Airspan No.	Note
POE++ PSU,60W,IN 100-240VAC,OUT 56VDC/1.2A & US AC Cable	VNG-PSU-US-ID-POE++1	903-03-110	One per unit
AC ADAPTER,60W, IN 100-240VAC,OUT 12VDC/5A & US AC Cable	VNG-PSU-US-ID-AC-1	903-03-111	One per unit

Note: Unit variant determines the PSU type required.

3.2.4 Verify Components

The following figures display various AirVelocity 1500 components and accessory kits.

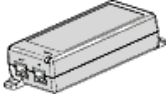
Table 9 AirVelocity 1500 Components

Parts	Images
AirVelocity 1500 Unit	
Suspended Ceiling/Ceiling mounting plate + hardware	
Locking Pin	
Security cable (suspended ceiling mounting)	
AC to POE++ power supply	
AC to DC power Supply	

AirVelocity 1500 is shown below displaying the Copper Ethernet ports and the GPS connection panel.

Figure 2: AirVelocity 1500 Ports (DC Variant)

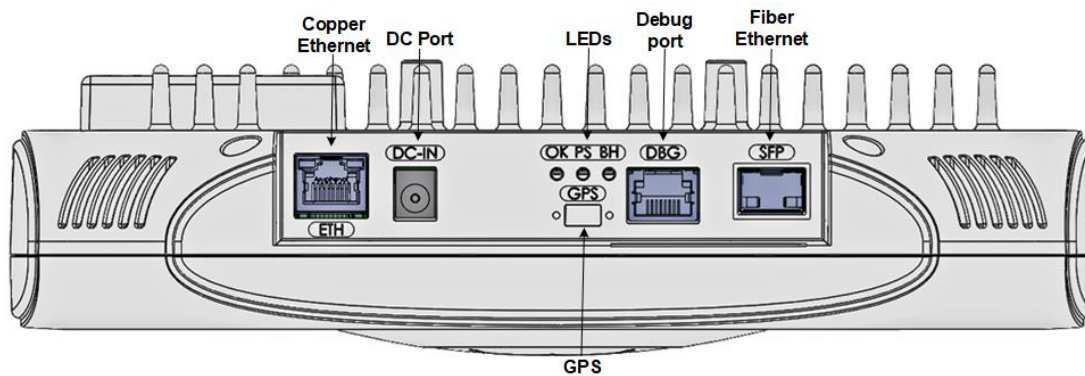

3.2.5 Physical Dimensions

3.2.5.1 Dimensions

AirVelocity 1500 is an indoor enclosure. Below are the AirVelocity and related parts dimensions (H x W x D):

Table 10. AirVelocity 1500 Physical Dimensions

Part	Dimensions (H x W x D)
AirVelocity 1500	250 x 250 x 60 mm / 9.84 x 9.84 x 2.36 in.
Mounting plate for unit (ceiling)	160 x 163.1 mm x 13.50 Height
Rail plate (ceiling)	52.9 x 52.9 mm x 18 mm (plate + pins)
Rail Bracket (ceiling & wall) – comes assembled on the AV 1500 unit	64 x 55.50 mm x 17.50 Height

3.2.5.2 Weight

The weight of all AirVelocity components are listed below:

Table 11: AirVelocity 1500 Components Weight

Component	Weight
Main unit	3 kg (6.6 lb)
Mounting plate for unit (ceiling)	263 g (9.28 oz.)
Rail plate (ceiling)	26 g (0.917 oz.) x 4 = 104 g (3.67 oz.)
Rail Bracket (wall & ceiling)	47 g (1.66 oz.) x 2 = 94 g (3.32 oz.)
Locking pin	7 g (0.25 oz.)

3.2.6 Environmental

Note: AirVelocity 1500 is not for external/outdoor use.

AirVelocity 1500 meets the following environmental requirements:

- ETSI EN 300-019-1-3 Operational (weather protected locations)
- ETSI EN 300-019-1-1 Storage (weather protected, not temperature controlled locations)
- xETSI EN 300-019-1-2 Transportation

Table 12. AirVelocity 1500 Environment Compliance

Type	Details	Standard Compliance
Operating temperature	-5°C to 40°C	ETSI 300 019 1-3 Class 3.1
Operating humidity	5% - 85% non-condensing	ETSI 300 019 1-3 Class 3.1
Storage temperature	-20°C to 70°C	N/A
Storage humidity	5% - 95% non-condensing	N/A
Ingress protection	IP40	N/A
Operational altitude	70-106 kPa as well as: From -60m to 1800m @ 40°C From 1800m to 4000m @ 30°C	N/A
Solar radiation	700 W/m ²	ETSI 300 019 1-3 Class 3.1

4 AirVelocity 1500 Installation

AirVelocity 1500 supports ceiling (suspended ceiling and conventional ceiling) and wall mounting by using these elements.

- AirVelocity 1500 Mounting Kit:
 - Ceiling mounting plate – used for mounting on either a suspended ceiling or a conventional ceiling
 - Rail plate – used for mounting on a suspended ceiling – 4 provided
- Rail bracket (with screws, M5x 8mm x4) in AirVelocity 1500 package – to be attached to the AirVelocity unit for ceiling mount (suspended or conventional) & wall mount.

Note: AirVelocity 1500 Mounting kits are available separately.

4.1 Ceiling Mount

The following defines the AirVelocity 1500 ceiling mount assembly procedure for a suspended ceiling and a conventional ceiling.

Note: Prior to assembly, in any mounting scenario, determine where the unit is to be installed.

4.1.1 Suspended Ceiling Assembly

1. Determine the optimal position where the AirVelocity unit is to be installed at an intersection between the suspended ceiling rail supports.
2. Remove the AirVelocity unit from the packaging and assemble the two (2) rail brackets (supplied) using the four (4) flat-head screws (M5x8 – supplied) to the threaded holes in the rear side of the unit, in the same orientation as displayed below:

Figure 3: Assemble Rail Brackets to the Unit

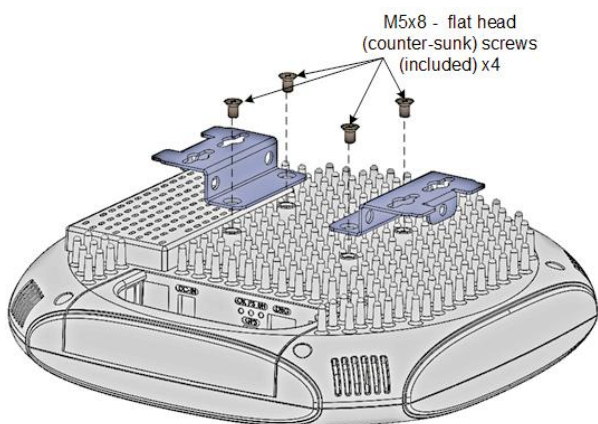

3. Before beginning assembly - fasten the Safety Cable (included) to a secure riser within the ceiling cavity above the intended installation area.
4. Assemble the four (4) Rail plates (triangular) onto the Ceiling mounting plate.
5. Insert the screws into the stud slides (4).
6. Attach the fiber washer & the wing nut onto the threaded studs (4).
7. Verify that the four (4) Rail plates slide freely in the slot(s).

Figure 4: Assemble Rail Plates to the Mounting Plate

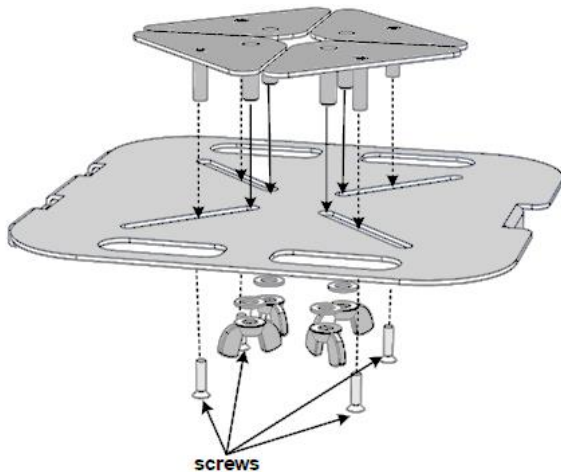

8. At the pre-determined juncture of the suspended ceiling's rail supports, position the assembled Mounting plate & rails onto the suspended ceiling's rail supports.

Figure 5: Ceiling Mounting Plate & Rails onto Ceiling Rails

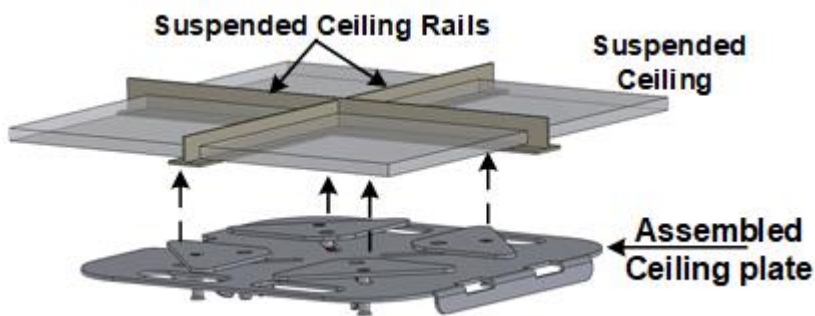

9. Slide the triangular Rail plates (4) so that they clinch the ceiling rails at the rail's intersection.

Figure 6: Slide and Clinch the Rail Plates onto the Ceiling Rails

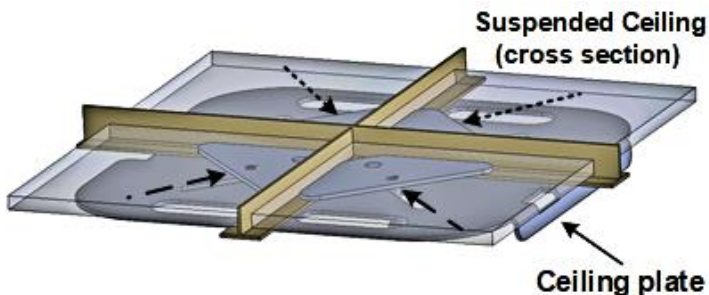

10. Tighten the four (4) wing nuts.
11. Lift the AirVelocity unit into position and engage the Rail bracket projections so they enter into the securing slots on the Ceiling mounting plate.

Figure 7: Engage the Rail Brackets Projections into the Ceiling Plate Slots

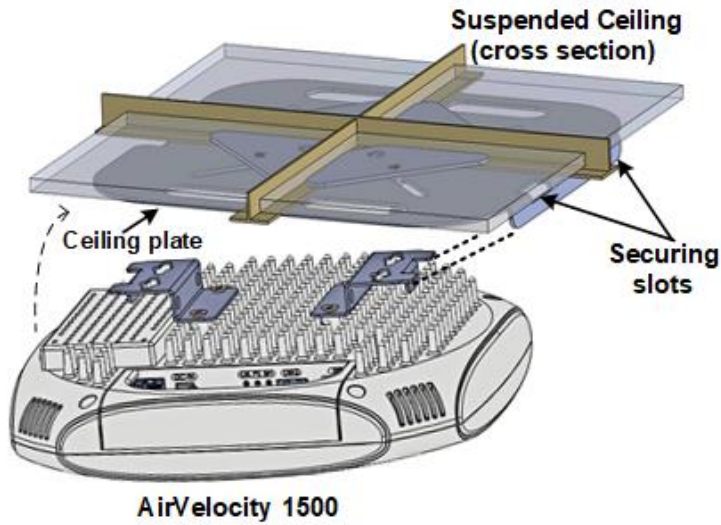

12. After the Rail bracket projections are in the slots swing the unit into the other side of the Ceiling mounting plate, insert and secure the Locking pin (supplied) through the hole on Rail bracket and the Ceiling mounting plate.

Figure 8: Swing Unit into Place and Insert the Locking Pin

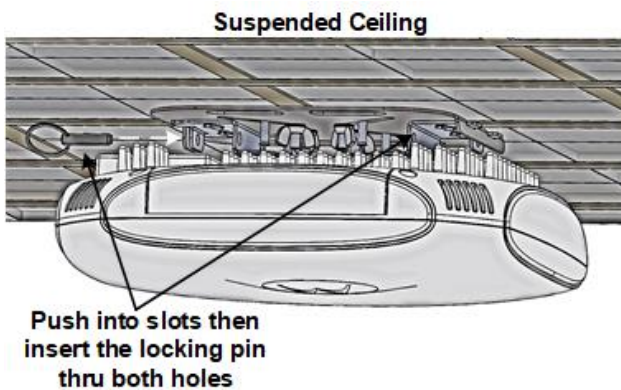

13. Once the Locking pin has been secured, insert and click closed the Safety cable (supplied).

Figure 9: Insert and Click Close the Safety Cable

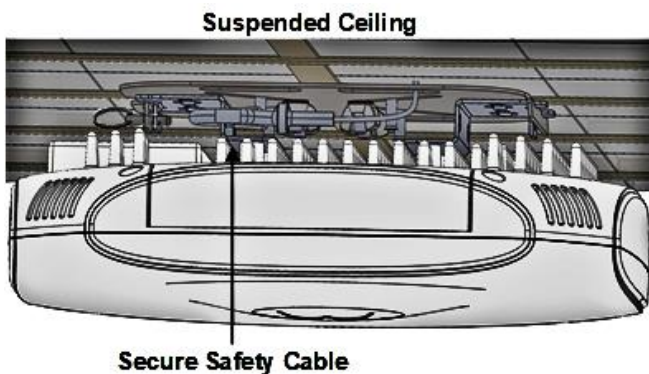

14. Remove the plastic cover to expose the connectors.
15. Connect the necessary cables to the relevant ports.
 - Connect to power
 - Copper Ethernet port – ETH – if applicable
 - Fiber Ethernet port – SFP – if applicable
 - GPS cable - to the GTPS port – when required
 - Debug port – if needed
16. Once all connections are completed, replace cover.

4.1.2 Conventional Ceiling Assembly

1. Determine the required location where the AirVelocity unit is to be installed on the conventional ceiling.
2. Remove the AirVelocity unit from the packaging and assemble the two (2) rail brackets (supplied) using the four (4) flat-head screws (M5x8 – supplied) to the threaded holes in the rear side of the unit, in the same orientation as displayed below:

Figure 10: Assemble Rail Brackets to the Unit

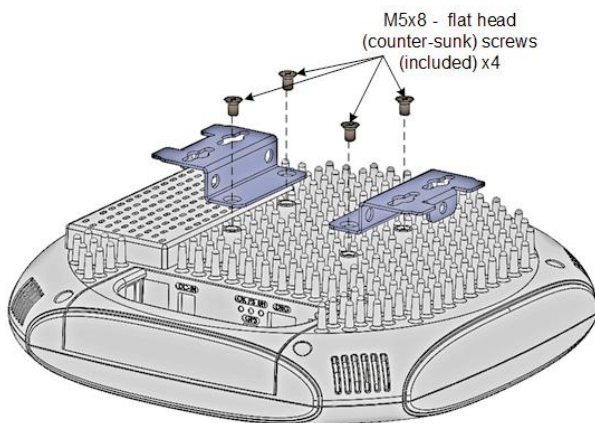

3. Position the Ceiling mounting plate on the ceiling. Be sure to position the Ceiling mounting plate straight to ensure the unit sits as required.
4. Mark the screw positions carefully through the diagonal slots on the Ceiling mounting plate onto the ceiling.
5. After drilling holes and inserting approved ceiling anchors (plugs) fasten the Ceiling mounting plate to the ceiling with approved screws and washers (not included).

Figure 11: Attach Mounting Bracket to Standard Ceiling

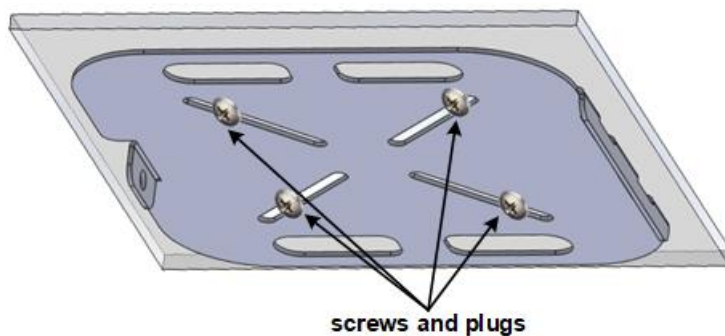

6. Mounting plate is installed and ready for AirVelocity 1500 mounting.

Note: Screws and washers (x4) and any necessary hardware are not supplied by Airspan and are the responsibility of the installer. Use appropriate ceiling hardware according to field conditions.

7. Lift the AirVelocity unit into position and engage the Rail bracket projections so they enter into the securing slots on the Ceiling mounting plate.

Figure 12: Mounting AirVelocity 1500 on Conventional Ceiling

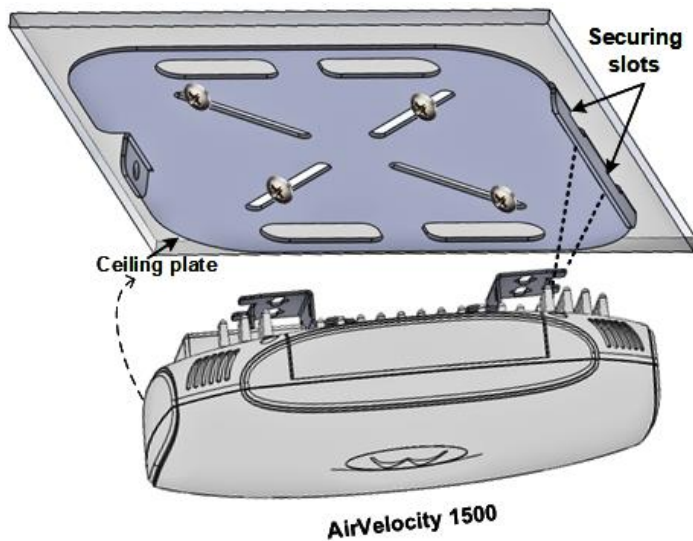

8. Once the rail bracket projections are in the slots swing the unit into the other side of the Ceiling mounting plate insert and secure the Locking pin (supplied) through the hole on Rail bracket and the Ceiling mounting plate.

Figure 13: Insert & Secure Locking Pin

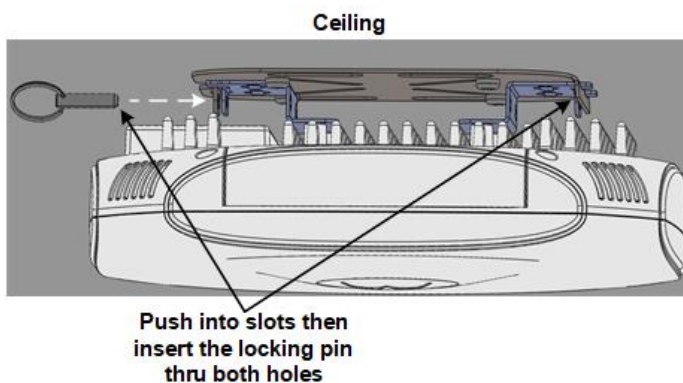

9. Remove the plastic cover to expose the connectors.
10. Connect the necessary cables to the relevant ports.
 - Connect to power
 - Copper Ethernet port – ETH – if applicable
 - Fiber Ethernet port – SFP – if applicable
 - GPS cable - to the GTPS port – when required
 - Debug port – if needed
11. Once all connections are completed, replace cover.

4.2 Wall Mount Assembly

The following defines the wall mounting procedure.

1. Determine the required location where the AirVelocity unit is to be installed on the wall.

Figure 14: Assemble Rail Brackets to the Unit

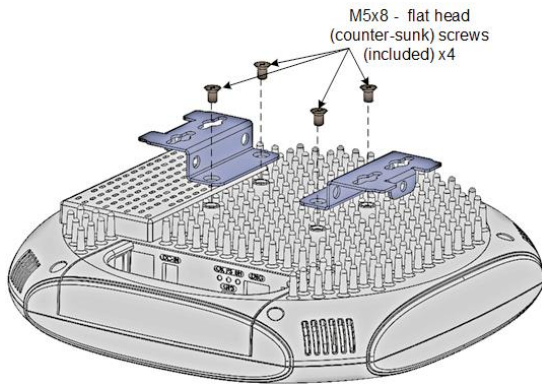

2. Utilize the marking template supplied with the AirVelocity unit and position it against the wall where the unit is to be mounted. Be sure to position the template straight and level mounting to ensure the unit sits level.
3. Mark the holes positions carefully through the template (supplied) onto the wall.
4. Drill the four (4) holes. After drilling insert wall plugs (x4) (not included).

Note: Wall plugs (x4) and necessary hardware are **not** supplied by Airspan and are the responsibility of the installer. Use appropriate wall plugs according to field conditions.

5. Drive the screw(s) into the wall just far enough for the screw heads to stick out from the wall, slightly more than the shoulder thickness of the head of the screw in order to hold the Rail brackets snugly.

Figure 15: Insert Anchors & Screws in Wall

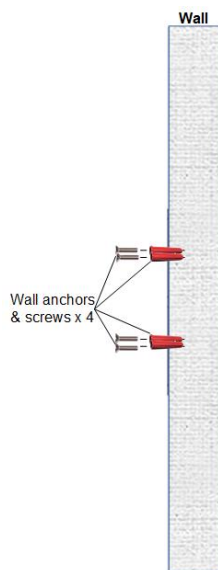

6. Place the AirVelocity's Rail brackets onto the screws heads protruding from the wall.

Figure 16: Insert Anchors & Screws in Wall

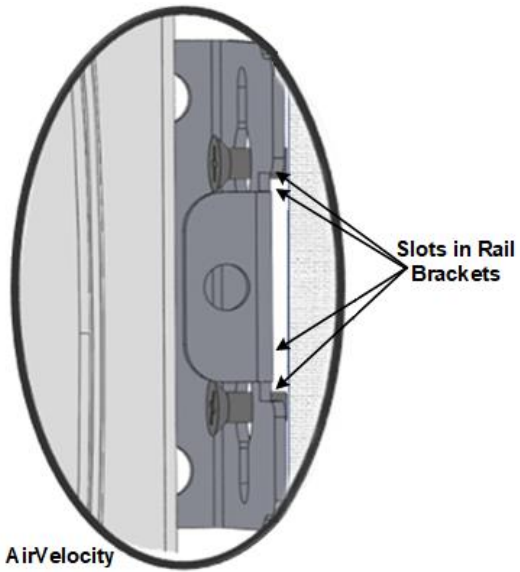

7. Push down slightly to engage the heads of the screws onto the slots.

Figure 17: Push Down to Engage Screw Heads

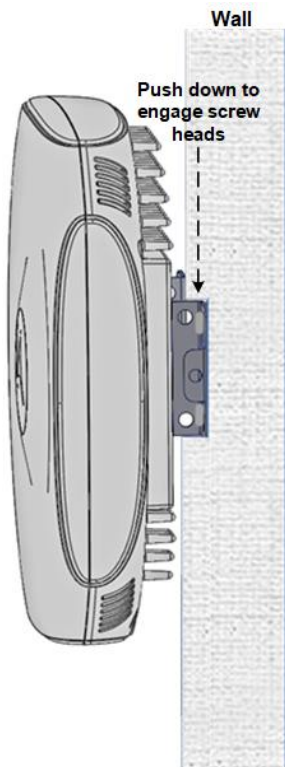

Remove the plastic cover to expose the connectors.

8. Connect the necessary cables to the relevant ports.
 - Connect to power
 - Copper Ethernet port – ETH – if applicable
 - Fiber Ethernet port – SFP – if applicable
 - GPS cable - to the GTPS port – when required
 - Debug port – if needed
9. Once all connections are completed, replace cover.

4.3 LED Display

The LEDs on the unit panel, provide unit status indication.

When powering up refer to the following table for indication of current status:

Table 13: LED Display

Name	Color	Status	Description
eNB Status LED (OK LED)			
Powering Up	White	On Continuously	Till the eNodeB SW starts loading
Software initiating	Green	Blinking (~3Hz)	During initiating process till “All Running”
Normal Operation	Blue	On Continuously	Normal operation (no alarm)
Major Alarm	Yellow/Orange	On Continuously	Service not affected
Critical Alarm or Sector OOS	Red	On Continuously	Service affected
Power Source LED (PS LED)			
POE+	Blue	On Continuously	The unit is powered from PoE+ (802.3at) class 4 source
POE++/DC	Green	On Continuously	The unit is powered from PoE++ (802.3bt) Class 6 or DC source

5 Connect and Manage Cables

5.1 DC Cable Connection

Insert the DC power plug into the DC IN on the panel of the unit.

Figure 18: DC Power Plug



Figure 19: DC In - Panel



5.2 Mounting the AC to POE++/DC Power Supply

The AC to POE++/DC power supply should be mounted on a wall in close proximity to the AirVelocity 1500 unit. Mount the power supply with screws through the two (2) holes on the unit's frame. The power supply should be mounted close to an available electrical outlet.

5.3 Ethernet Cable Installation

Before connecting to the appropriate port you can manage and store any excess cable by winding it and tying it off. This takes up any excess slack and presents a more thorough and orderly installation.

5.3.1 Copper Ethernet Cable

Typical RJ45 connection (when applicable).





5.3.2 Fiber Ethernet (SFP) Cable

SFP module and connector (when applicable), **not** supplied by Airspan.

6 GPS Antenna Mounting

6.1 Verify the Parts and Kits

Table 14: GPS Kit Contents

Item	Image
Active GPS Antenna	
10m GPS Cable - RG58 SMA-F to SMA-M	
GPS Antenna Mounting Bracket	
Double Sided Sticker	

Note: The GPS antenna is an active antenna. The 10m extension cable must be used for proper operation. Directly connecting the antenna to the eNodeB is not allowed.

The antenna enclosure is a waterproof IP67 and can be mounted both outdoors and indoors.

Figure 20: GPS Antenna



The antenna installation supports three different installation options:

Option 1 – Installation on the inside of a window

1. Remove the paper from one side of the double sided sticker and attach the sticker on the front side of the antenna.
2. Thoroughly clean the area of the window where you intend to attach the GPS antenna.
3. Remove the paper from the other side of the sticker and fix the antenna on the window from the inside. Verify there are no obstacles between the window and the outside (so the antenna can access “clear sky”).
Position the antenna either on a sealed (un-openable) window or close to the hinge side.
4. Connect the 10m RF cable to the antenna. Make sure to firmly tighten the SMA connector.
5. Route the cable to the base station and connect it to the GPS port on the base station. Make sure to firmly tighten the SMA connector.

Option 2 – installation on the outside of a window

1. Remove the paper from one side of the double sided sticker and attach the sticker on the back side of the antenna.
2. Thoroughly clean the area of the window where you intend to attach the GPS antenna.
3. Remove the paper from the other side of the sticker and fix the antenna on the outside of the window. Verify there are no obstacles blocking the window and the outside (so the antenna can access “clear sky”).
 - Position the antenna either on a sealed (un-openable) window or close to the hinged side.
4. Drill a hole near the window to pass the 10m RF cable through. Make sure to leave enough RF cable on the outside so the window can be opened without applying any strain on the RF cable.
5. Connect the 10m RF cable to the antenna. Make sure to firmly tighten the SMA connector.
6. Seal the hole with a sealing material (RTV or similar).
7. Route the cable to the base station and connect it to the GPS port on the base station. Make sure to firmly tighten the SMA connector.

Option 3 – installation on a mounting bracket

1. Take the supplied bracket and attached it to the wall using one or two screws and appropriate wall plugs (screws are not supplied).
2. Remove the paper from one side of the double sided sticker and attach the sticker on the back side of the antenna.
3. Remove the paper from the other side of the sticker and mount the antenna on the bracket.
4. Verify there are no obstacles blocking the antenna and there are “clear sky” conditions.
5. Drill a hole near the bracket to pass the 10m RF cable through. Make sure to leave enough RF cable on the outside so there isn't any strain on the RF cable.
6. Connect the 10m RF cable to the antenna. Make sure to firmly tighten the SMA connector.
7. Route the cable to the base station and connect it to the base station GPS port. Make sure to firmly tighten the SMA connector.

A Job Sheet

This job sheet enables the users to keep track of their installation. It covers all the prerequisites required for accomplishing the AirVelocity 1500 installation.

Site Requirements
<ul style="list-style-type: none"> ○ Position on ceiling / wall ○ Access restrictions (local regulations) (when applicable) ○ Method of reaching ceiling / wall positions (ladders, elevated work platform) ○ Available AC outlet ○ Configuration programming details known ○ Point of connection for Ethernet ○ All equipment items available at the installation site <ul style="list-style-type: none"> ○ Air Velocity 1500 unit ○ Mounting plate(s) – as required ○ AC to POE++ power supply ○ Cable(s) assembly ○ GPS antenna kit (where applicable – sold separately)
Tool Requirements (For further information, see Verify the Tools.)
<ul style="list-style-type: none"> ○ Large flat screw driver ○ Small flat blade screw driver ○ Medium Philips head screw driver ○ Hammer (to insert and set the wall plugs)
Required Ancillary Equipment
<ul style="list-style-type: none"> ○ Laptop PC for initial configuration

B Checklist

During installation, review and perform all the steps on this checklist (in the given order). This checklist is meant for the person who performs the AirVelocity 1500 installation.

Tip: To make sure you complete all the tasks, detach or print this checklist and use it as a job aid. After performing, check off each task.

Procedure	Action	Check If Performed
Verify the prerequisites	Verify the site requirements.	<input type="checkbox"/>
	Verify the installation requirements.	<input type="checkbox"/>
	Verify the tool requirements.	<input type="checkbox"/>
	Verify the parts & kits required.	<input type="checkbox"/>
AirVelocity 1500 installation	Assemble rail brackets on AirVelocity unit two (2) places.	<input type="checkbox"/>
	Install the Ceiling mounting plate (as required)	<input type="checkbox"/>
	Install AirVelocity 1500 on the Ceiling mounting plate (as required).	<input type="checkbox"/>
	Install GPS antenna	<input type="checkbox"/>
Connect & manage Cables	<ul style="list-style-type: none"> ▪ Connect to Copper Ethernet (if applicable) ▪ Connect to Fiber Ethernet (if applicable) 	<input type="checkbox"/>
Connect power system	Connect power	<input type="checkbox"/>

C Abbreviations

Table 15: ABBREVIATIONS & DEFINITIONS

Term	Definition
3GPP	3rd Generation Partnership Project, responsible for LTE
ACS	Adjacent Channel Selectivity is a measurement of a receiver's ability to process a desired signal while rejecting a strong signal in an adjacent frequency channel. ACS is defined as the ratio of the receiver filter attenuation on the assigned channel frequency to the receiver filter attenuation on the adjacent channel frequency
dB	Decibel. A logarithmic unit used to describe a ratio (such as power ratio in radio telecommunications)
dBm	An abbreviation for the power ratio in decibels (dB) of the measured power referenced to one milliwatt (mW). It is used as a convenient measure of absolute power because of its capability to express both very large and very small values in a short form
eNodeB	Evolved Node B, is the element in E-UTRAN of LTE
FDD	Frequency-Division Duplexing. A transceiver mode where the transmitter and receiver operate at different carrier frequencies
IPSec	Internet Protocol Security is a protocol suite for securing Internet Protocol (IP) communications by authenticating and encrypting each IP packet of a communication session
LED	Light Emitting Diode
LTE	Long Term Evolution
PSU	Power Supply Unit
ROHS	Restriction Of Hazardous Substances
RRC	Radio Resource Control. A Sub-Layer in LTE responsible for Broadcast of system information, paging, security functions, radio bearer control, etc...
SDR	Software Defined Radio
SyncE	Synchronous Ethernet. A method for maintaining synchronous communication over Ethernet using the physical layer (L1), as defined by ITU-T G.8262
TDD	Time-Division Duplexing. A transceiver mode where the transmitter and receiver operate on the same carrier frequency
UE	User Equipment. The end user in LTE
WEEE	Waste Electrical and Electronic Equipment